

# CONDE<sup>®</sup>

## SPORTS INTERNATIONAL

---

### Tennis accessories catalog



# Universal Sport Blue Line



### Tennis Net Post Court Royal TP 80

Square post, 80 x 80 mm. Special reinforced aluminium profile with groove for fastening the net holding rod. Internal trapeze tensioning mechanism with aluminium key for easy net tensioning. Clip-on cap made of cast aluminium including safety chain. Overall length of posts: 142 cm. Weight: 10.5 kg. Aluminium ground sleeves, depth of insertion 35 cm, complete with cast aluminium cover. Meets the European DIN EN 1510 safety standard.

**No. 40448** blue powder-coated



### Umpire Chair Court Royal Deluxe

This aluminium umpire chair with European Seal of Approval DIN EN 131, meets the highest standards. The ladder with its especially wide slip-proof rungs, as well as the projecting supports with four base plates, give this chair optimum stability. The middle plate between the ladder and the supports provides extra durability. The seat mount has an extra crossbar behind the blue, UV-resistant body-contoured seat.

**No. 408089** blue powder-coated

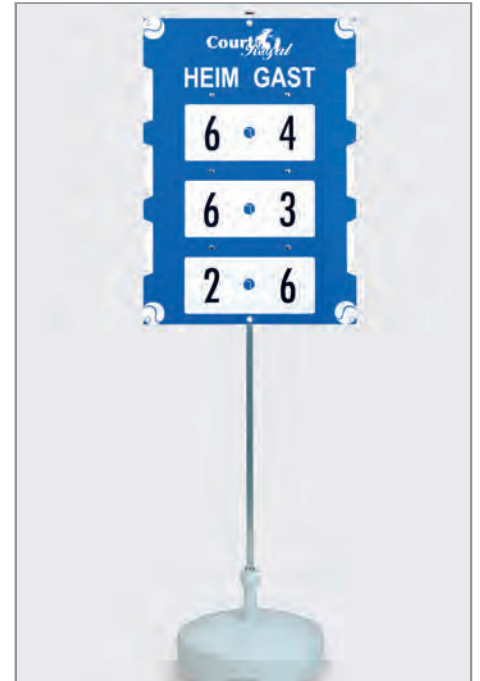

### Court Royal Pointer

Scoreboard with 6 adjustable disks for 3 set scores. Visible on both sides, clearer and easier to read, weather-resistant and light-resistant plastic. Easy mounting on fence or net. Complete with mounting brackets. Size 56x80 cm with 10 cm big digits.

**No. 40829** blue (without stand)

**No. 40831** blue (with stand)



### Wind Screen Exclusive 2 x 12 m

**No. 41512** blue



### Single Net Rods

**No. 40647** blue



### Bench Freiburg 150 cm long, blue

2 plastic legs and 9 multi-chamber plastic slats with reinforcement bracket in the center, foldable. Proven high-quality. Weight approx. 15 kg.

**No. 411991** blue



### Bench Helgoland 150 cm long, blue

2 plastic legs and 12 multi-chamber plastic slats with reinforcement bracket in the center, foldable. Practical and comfortable to sit on. Weight approx. 19 kg.

**No. 412071** blue



# Index

<b>Maintenance Equipment</b>	<b>6 – 13</b>
<b>Line Tapes - Accessories</b>	<b>14 – 16</b>
<b>Nets - Posts - Accessories</b>	<b>17 – 25</b>
<b>Scoreboards</b>	<b>26 – 27</b>
<b>Umpire Chairs</b>	<b>28 – 29</b>
<b>Benches</b>	<b>30 – 33</b>
<b>Court Treatment Devices</b>	<b>34 – 43</b>
<b>Sprinkler</b>	<b>44 – 45</b>
<b>Shoe Cleaner - Waste Bins - Signs</b>	<b>46 – 48</b>
<b>Ball Machines - Training Walls</b>	<b>49 – 54</b>
<b>Ball Baskets - Balls</b>	<b>55 – 58</b>
<b>Kid's Tennis</b>	<b>59 – 63</b>
<b>Training Devices</b>	<b>64 – 66</b>
<b>Information Boards</b>	<b>67 – 69</b>
<b>Windscreens</b>	<b>70 – 71</b>
<b>Court Accessories</b>	<b>72 – 75</b>
<b>Sport and Games</b>	<b>76 – 85</b>

# Index

Article	Page	Article	Page	Article	Page
Absorbing Roller Special	43	Hockey Set	65	Soccer	76, 77
Adjustable Nozzle	44	Hose	45	Softball, yellow	59
Advertising Bench	30	Hose Holder	45	Spare Parts for Tennis Net Posts	20
Advertising Screen	70, 71	Information Board	67	Special Rake	9
Advertising Empire's Chair	28	Iso-Line	14	Special Smoothing Mat for Silica	34
Air Tennis	53	Jowo Tennis Caddy	56	SpeedTrac Sports Radar	54
Aluminium Clay Spreader	8	Line Brush	40	Speziala Lines	15
Aluminium Multi-Purpose Shovel	7	Line Lightening Sweeper	41	Spray Nozzle	41
Aluminium Plow	9	Line Master	41	Sprinkler	40
Aluminium Scraper	9	Line Roller	16	Stage Balls	59
Aluminium Surface Profile Blade	9	Line-Stamper	13	Stage Rackets	59
Badminton	80, 81	Lines	14, 15	Stage Lines	63
Balls	58, 59	Linien Blitz	41	Standard Dividing Net	22, 23
Ball Back	52, 53, 54	Manual Roller	12	Steel Wire Broom	38
Ball Basket	56, 57	Marking Cone	65	Streetball	83, 85
Ball Caddy	50, 56, 57	Marking Line	14, 15	Support Rod	23
Ball Catcher	55	Marking Lines for Children's Tennis	63	Tennis Ball Catcher	55
Ball Collector	50	Marking Strips	14	Tennis Balls	58, 59
Ball Mover - Trolley	56	Marking Trolley	16	Tennis Benches	5, 30, 31, 32, 33
Ball Pickup Tube	57	Match Liner	41	Tennis Caddy	49, 56, 57
Ball Throwing Machine	49, 50, 51	Match Pointer	26, 27	Tennis Court Drying Set	43
Basketball	85, 86, 87	Match Timer	48	Tennis Court Reservation Clock	61
Beach Volleyball	80	Measuring Tape	16	Tennis Lines	14, 15
Benches	5, 30, 31, 32, 33	Megaphone	73	Tennis Net	22, 23
Bimbi Children's Tennis	60, 61, 62	Mid Court Tennis Net	60, 61, 62	Tennis Net Hanging Bracket	25
Broom	13, 33, 38, 39, 40	Motor Roller	10, 11	Tennis Net Post	5, 17, 18, 19, 20, 21
Center Strap	24	Mobilissima	74	Tennis Net System	21
Children's Net System	60, 61, 62	Net	22, 23, 72	Tennis Court Broom	38, 39
Children's Racket	59	Net Post	5, 19, 20, 21	Tennis Court Drying Set	43
Circular Sprinkler	44	Net Rod	22	Tennis Court Number	48
Clax Ball Trolley	56	Numbers	48	Tensioning Screw	25
Clax Boxes	6	Optiplan	36	Training Aid	64, 65, 66
Clay Spreader	12	Paper Basket	47	Training Wall	52, 53, 54
Coconut Smoothing Mat	35	Part and Full-Circle Sprinkler	40	Tribune	74
Collapsible Tennis Post	20	Platzfit	35	Tribune Seats	75
Combination Leveler	34	Playmate Ballmachine	50, 51	Turbo Broom	13
Combined Hand Leveler	34	Plow	9	Turbo Quadrilateral Sprinkler	44
Coordination Ladder	65	Practice Wall	52, 53, 54	Tutor Ballmachines	49
Court Dimensions	5, 86	Professional Broom	13	Tubular Anchor	15
Court Royal Tennisnets	22, 23	Rail Aluminium / Wood	37	Universal Absorbing Roller Special	42
Court Side Bench	5, 30, 31, 32, 33	Rake	8, 9	Universal Sports Post	81
Distance Measurer	16	Ranking List	68	Volleyball	78, 79, 80
Dividing and Stop Net	72	Ratchet Tensioner	15	Waste Bin	47
Drag Cord	37	Referee Chair	28, 29	Water Roller	42
Drag Net	32, 33, 34	Replacement Marking Strips	14, 15	Wheelbarrow	7
Drag Net Material	36	Reservation Plan	69	Wimag Motor Roller	11
Drain Cleaner	8	Rolldry	43	Wind Screen	70, 71
Dressing Spreader	9	Rubber Rake	8	Wire Waste Bin	47
Equipment Holder	42	Rubber Squeegee	8	Wooden Handle	6
Fixing Clamp	15	Sand Spreader	12		
Floor Covering Uniflex	73	School Tennis	58, 59, 60, 61, 62, 63		
Folding tripod	44, 54	Scoreboard	5, 26, 27		
Frankfurt Shovel	7	Seats	28, 75		
Garden Benches	5, 30, 31, 32, 33	Shoe Cleaner	46		
Geka Adapters	44	Shoe Cleaning Tub	46		
Granulate	6	Shovel	7		
Granulate Broom	38	Showcase	67		
Granu-Top	38	Sign for Court Rules	48		
Ground Sleeves	20	Silica Sand Broom	38		
Hand Brush	40, 41	Single Net Rods	5, 22, 25		
Hand Brush Holder	42	Small Court Tennis Net	60, 61, 62		
Hand Leveler	8	Smash Back	52		
Handball Goal	77	Smoothing Mat	34, 35		
Handle Holders	42	Smoothing Mat, hard PVC	34		
Handles	6				

# Court Dimensions

## POST- AND NET DIMENSIONS

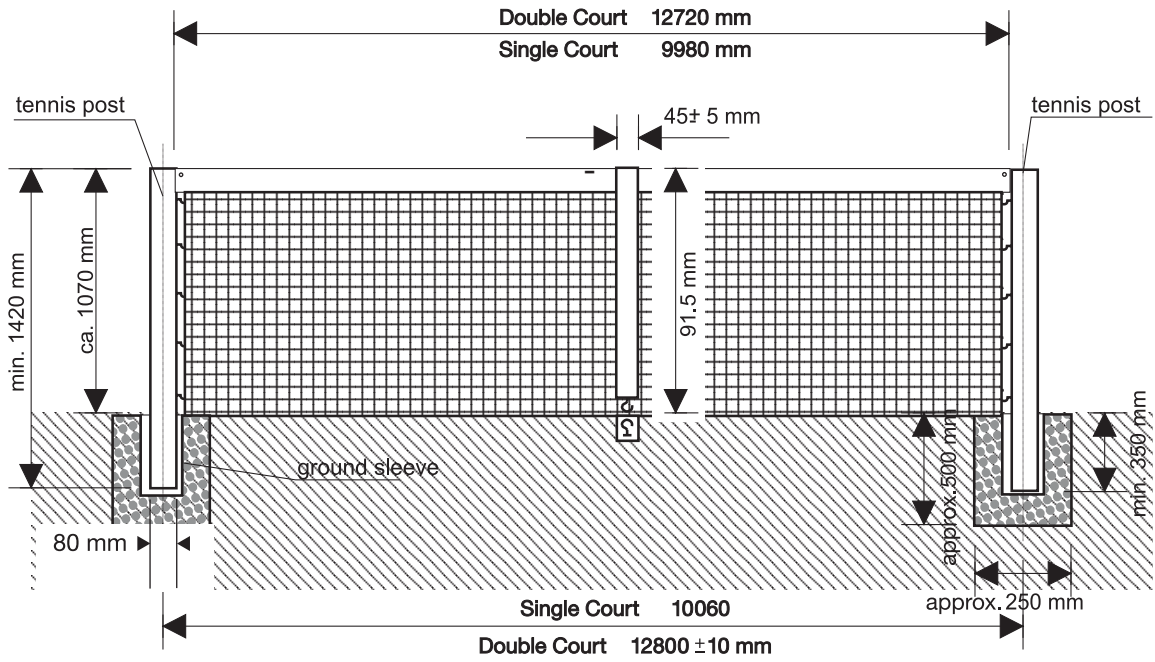

## COURT DIMENSIONS

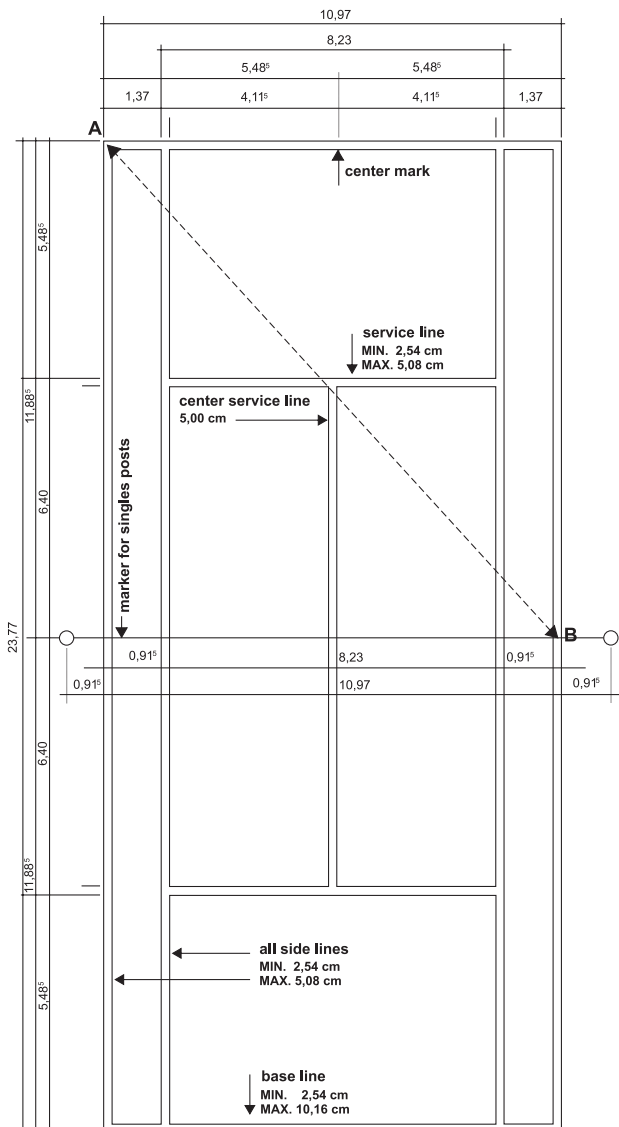

## TOURNAMENT COURT DIMENSIONS

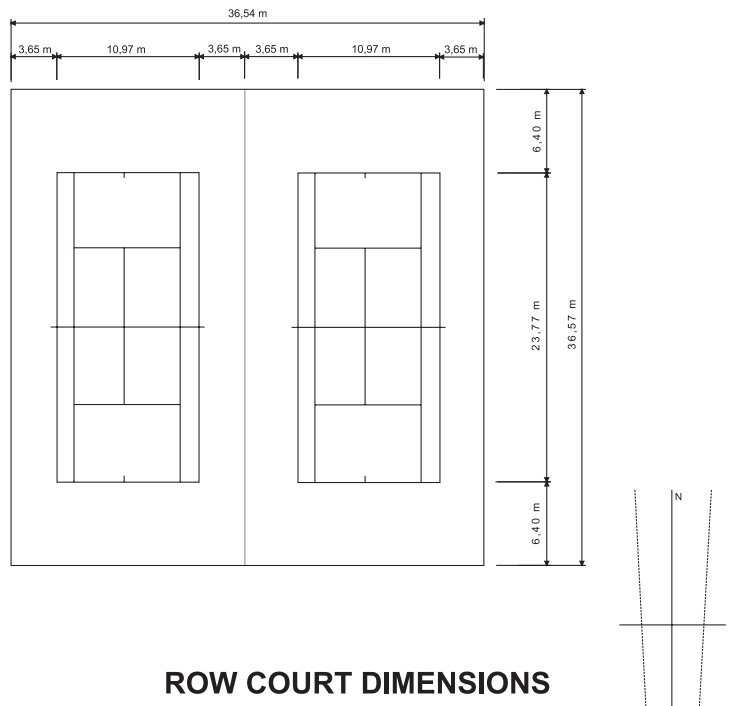

## ROW COURT DIMENSIONS

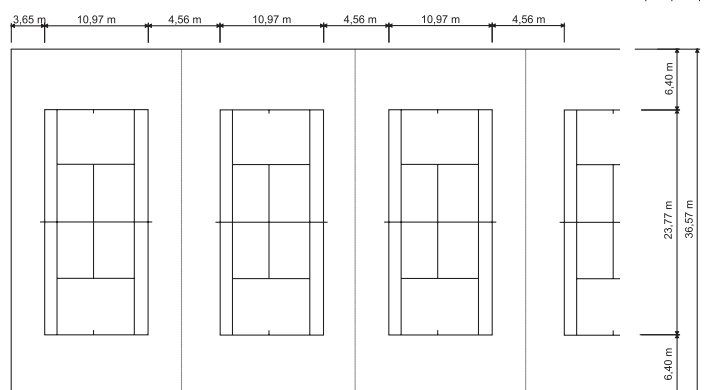

# Maintenance Equipment



## Clay Box

A combination of fiberglass-reinforced plastic and resin make this clay box very stable. The material is UV and weather resistant. Metal parts are stainless steel. Every clay box has a hinged lid.

Color: gray, orange.

<b>No. 41290</b>	700 kg	550 Ltr.	134 x 99 x 78 cm	
<b>No. 41291</b>	700 kg	550 Ltr.	134 x 99 x 78 cm	Material removal below
<b>No. 41300</b>	1100 kg	750 Ltr.	134 x 99 x 96 cm	
<b>No. 41301</b>	1100 kg	750 Ltr.	134 x 99 x 96 cm	Material removal below
<b>No. 41310</b>	1500 kg	1100 Ltr.	163 x 121 x 101 cm	
<b>No. 41311</b>	1500 kg	1100 Ltr.	163 x 121 x 101 cm	Material removal below
<b>No. 41312</b>	2200 kg	1500 Ltr.	184 x 143 x 104 cm	Material removal below



## Rubber Granules

For scattering onto slippery surfaces in indoor tennis courts. Grain size 0.5–1.5 mm. Special granulate, non-abrasive, dust-free, anti-static, odorless, non-slip. Supplied in 25 kg sacks. Ideal for topping up.

<b>No. 47010</b>	Color: red
<b>No. 47020</b>	Color: green
<b>No. 47030</b>	Color: blue



## Wooden handle 24 mm

24 mm Ø, 1.5 m long. For rakes, rubber rakes, line sweepers, line guider, match liners, line brooms.

**NO. 40091**

## Wooden handle 28 mm

28 mm Ø, slightly tapered, 1.5 m long. For aluminum scraper, wooden rakes, aluminum rakes, plows.

**No. 40094**



# Maintenance Equipment



## Wheelbarrow Standard

Capacity: 85 l, 240 kg. Galvanized barrow with beaded rim, 1 pneumatic tire 400 x 100 with nylon sleeve bearing.

**No. 40103**



## Wheelbarrow Universal 100 I

Capacity: 100 l. Seamless pressed, galvanized barrow with sturdy rounded rim, 2 pneumatic tires, load 300 kg.

**No. 401021**



## Wheelbarrow Court Royal

This newly developed wheelbarrow for tennis sand should not be missed on any tennis court. Capacity 250 l, polyethylene synthetic bottom, 6 mm wall thickness, all-round stable rim, break proof, high abrasion resistance and complete UV-stability, stable 1" tubular steel frame, phosphated and plastic-coated, reinforcing cross-bars for stable bottom, simple emptying via tube runners, air tyres 4.00 - 8 ball bearings with pneumatic wheels, load-carrying capacity 350 kg.

**No. 401025**



## Aluminium Multi-Purpose Shovel

To spread clay or to remove old material and leaves, complete with handle.

**No. 40101** Size: 380 x 380 mm

**No. 40100** Size: 370 x 270 mm



## Frankfurt Shovel 1)

Round shovel made of steel, painted red, oil-hardened with ashwood handle.

**Nr. 40099**

## Holstein Shovel 2)

Square shovel made of steel, painted red, oil-hardened with ashwood handle.

**Nr. 40098**

# Maintenance Equipment

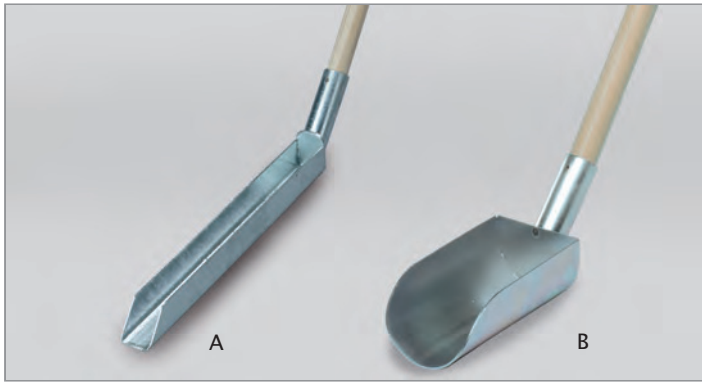

## Drain Cleaner A

To clean drain gutters. 5 cm wide, complete with wooden handle.  
**No. 40030**

## Drain Cleaner B

As above but 10 cm wide.  
**No. 40031**



## Guide Bar

Made of aluminium, collapsible, light construction, simple to handle. An essential tool for the groundkeeper for checking levels and finding hollows. Length 10 cm.  
**No. 40033**

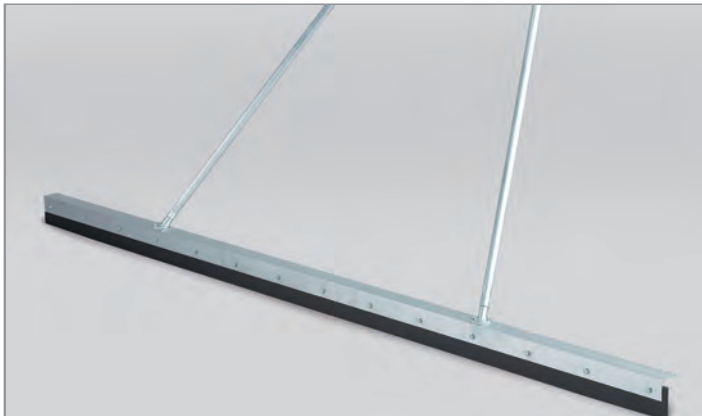

## Hand Leveler

Made of aluminium, with rubber blade. To wash in the top covering and clear puddles, 200 cm wide.  
**No. 40020**

## Spare rubber blade for hand leveler

**No. 40021**

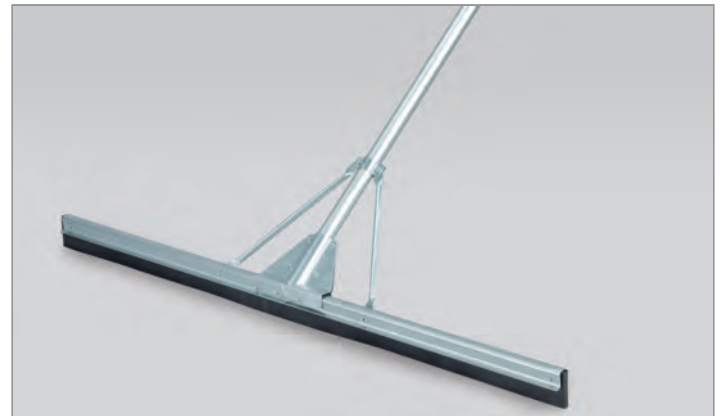

## Rubber Squeegee

Steel bar with rubber blade. Specially intended for stone removal. Light leveling of loose courts and water removal on hard surfaces, 100 cm wide, handle included.  
**No. 40022**



## Rubber Rakes

For fast removal of leaves and rubbish, without handle.  
**No. 40090** 50 cm wide  
**No. 40089** 70 cm wide

## Wooden Handle Ø 28 mm for Rubber Rakes.

**No. 40094**

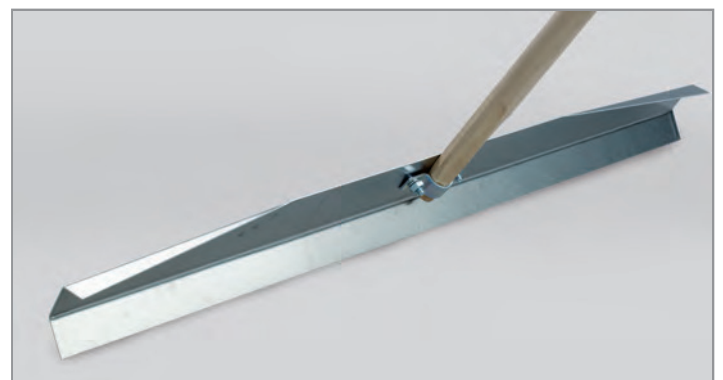

## Aluminium Clay Spreader

To fill in holes and level irregularities, 100 cm wide, without handle.  
**No. 40060**

## Wooden Handle Ø 28 mm for Rubber Rakes.

**No. 40094**

# Maintenance Equipment



## Wooden Rake

Triangular beech wood, 70 cm wide with saw blade, without handle.  
**No. 40040**

**Wooden Rake** as above, though without saw blade.  
**No. 40042**

**Saw Blade** for wooden rake.  
**No. 40051**

**Wooden Handle** Ø 28 mm  
**No. 40094**

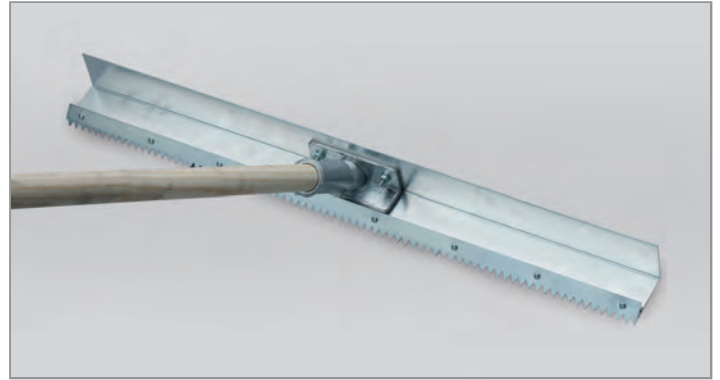

## Aluminium Plow

One side with steel band saw blade, the other side with solid profile, 70 cm wide.  
**No. 40050**

**Saw Blade for plough**  
**No. 40051**

**Wooden Handle** Ø 28 mm  
**No. 40094**



## Aluminium Surface Profile Blade

To smooth out irregularities, without handle.

**No. 40080** 80 cm wide  
**No. 40081** 150 cm wide

**Wooden Handle** Ø 28 mm  
**No. 40094**



## Aluminium Scraper

Double-sided tool, one side toothed to roughen surface, other side flat for spreading. 80 cm wide, without handle.

**No. 40070**

**Wooden Handle** Ø 28 mm.  
**No. 40094**



## Dressing Spreader

Trapezoidal shaped aluminium section dressing spreader. Light and easy to handle yet robust for precise distribution of material over large areas, 200 cm wide, without handle.

**No. 40084**

**Wooden Handle** Ø 28 mm  
**No. 40094**

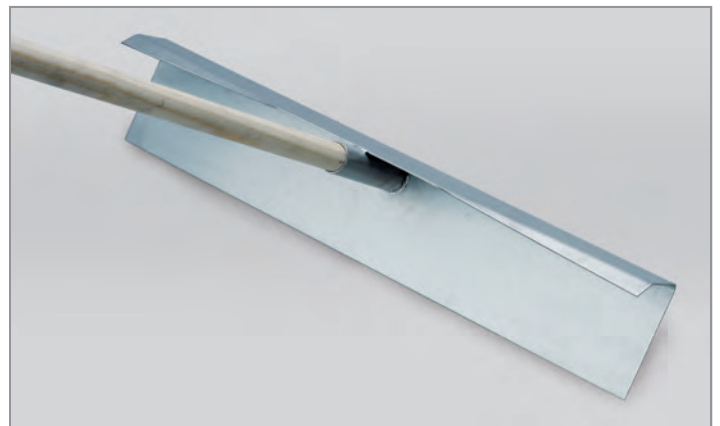

## Special Rake

Made of stainless steel, corrosion-resistant, for professional smoothing of clay courts, 66 cm wide, without handle.

**No. 40083**

**Wooden Handle** Ø 28 mm  
**No. 40094**





# Maintenance Equipment

## ZAGRO Motor Rollers

The ZAGRO tennis court rollers in longstanding proven type of construction and quality, with single-piece roller body without differential or with two-part roller body with compensation differential for better turning around of the roller. The mechanically turned off roller body characterizes this ZAGRO motor roller. The 800 mm wide trailing roll prevents the roller from sinking into the tennis court surface.

### Technical data:

Motor:	Honda GX 160, 4-stroke engine 4,0 kW at 3600 U/min.
Fuel:	unleaded gasoline
Drive:	hydraulic drive
Roller:	single-piece or split; width 900 mm, Ø 508 mm
Speed:	infinitely adjustable to approx. 6 km/h, forward and reverse
Working width:	900 mm
Weight:	empty ca. 350 kg, full ca. 470 kg
Dimensions:	length: 1800 mm, width: 990 mm, height 1100 mm



### Motor Roller Zagro One-part ZBW 06 EX OV

No. 40141 One-part roller body, without body panelling

### Motor Roller Zagro One-part ZBW 06 EX MV

No. 40153 One-part roller body, with body panelling



### Motor Roller Zagro Two-part ZBW 06 EXD OV

No. 40157 Two-part roller body, without body panelling

### Motor Roller Zagro Two-part ZBW EXD MV

No. 40158 Two-part roller body, with body panelling



### Motor Roller Zagro FUTURA -Self-Driving

Mount motor roller with a swivelling seat, rubber-coated, broad drive front wheel, split roller body with compensation differential for high maneuverability. Simple and easy rolling of the tennis courts.

### Technical data:

Motor:	Honda GX 160, 4-stroke engine 4,0 kW at 3600 U/min.
Fuel:	unleaded gasoline
Drive:	hydraulic drive
Roller:	single-piece or split; width 900 mm, Ø 508 mm
Speed:	infinitely adjustable to approx. 6 km/h, forward / reverse
Working width:	900 mm
Weight:	empty ca. 380 kg, full ca. 510 kg
Dimensions:	length: 1800 mm, width 990 mm, height: 1050 mm

No. 40152



# Maintenance Equipment

## USP Motor Rollers

The new Universal Sport hydraulic rollers are characterized by their solid construction and good looks. Due to the use of serial components, the rollers are cost-effective, long-lasting and easy to maintain. A special attention is paid on the work safety. Due to the suction-noise-insulation an easy rolling is possible. The rollers are equipped with an electronic, contactless ignition and an oil-warning control-system. All USP motor rollers are GS and TÜV proved.

### Technical data:

Motor:	Honda GX 160, 4-stroke engine 4,0 kW at 3600 U/min.
Fuel:	Unleaded gasoline
Drive:	Maintenance-free hydraulic drive with automatic decompression, easy start.
Roller:	single-piece or split; width 900 mm, Ø 480 mm
Speed:	infinitely adjustable to approx. 6 km/h, forward and reverse
Working width:	900 mm
Weight:	empty ca. 390 kg; full ca. 510 kg
Dimensions:	length: 1750 mm; width: 990 mm; height: 1080 mm

## Motor Roller USP I OV

**No. 40120** One-part roller body, without body panelling

## Motor Roller USP II OV

**No. 40130** Two-part roller body, without body panelling



## Motor Roller USP I MV

**No. 40132** One-part roller body, with body panelling

## Motor Roller USP II MV

**No. 40133** Two-part roller body, with body panelling

## Protective Plane

Made of high-quality PVC  
**No. 40160**



## Wimag Motor Roller MW 2000

WIMAG has developed a new motor roller on the basis of experience. The motor roller meets the requirements of the equipment safety legislation (GS) and has been approved by the German Technical Control Board (TüV). Rolling can now be carried out in both directions without turning around by placing the driver's seat at an angle of 90° into the direction of travel. The 4-stroke engine guarantees smooth running with a fully hydraulic drive and gentle starting and braking. An emergency shut-off ensures optimum safety for the operating personnel a split roller provides a minimum turning circle.

### Technical data:

Motor:	Honda GX 160, 4-stroke engine 4,0 kW at 3600 U/min.
Fuel:	unleaded gasoline
Drive:	Maintenance-free hydraulic drive enabling slow and infinitely variable starting
Roller:	Split roller, width 900 mm, Ø 620 mm.
Speed:	adjustable to approx. 6 km/h, forward and reverse
Working width:	900 mm
Weight:	empty 330 kg; full 590 kg
Dimensions:	Length: 1600mm; width: 1070mm; height: 1200mm

## Protective Plane for Motor Roller MW 2000

**No. 40151**

# Maintenance Equipment



## SANDY II – Tennis Sand Spreader

The new SANDY II was checked fundamentally and it makes the new sanding of the spring maintenance much more effective. Two helpers for the supply and half an hour time are sufficient in order to be able to spread the clay carpet like sand evenly distributed in one operation.

SANDY II is easy to operate by hand and it is able to take a maximum volume of ca. 120 clay. With its size of ca. 1000 x 500 x 600 mm it is very handy and has got an ideal weight of 50 kg. The working size is 990 mm.

The functional device for spreading clay was developed by experts and has been proven effectively on various courts. Even on uneven ground you get a completely smooth surface, which only has to be machined with a dragnet.

**No. 40142**



## Clay Court Cutter USP 10

Developed to reduce preparation work in spring to about one hour per court. Hard and moss-covered courts in autumn are no contest for this machine. The clay is removed completely and ejected in a strip. Depth is set to the millimeter with two butterfly nuts.

### Technical Data:

Length:	approx. 800 mm
Width:	approx. 850 mm
Height:	approx. 1000 mm
Cutting width:	approx. 655 mm
Weight:	approx. 75 kg
Motor:	Honda, 4-stroke, 4 kW/5.5 PS

**No. 40140**



## Manual Roller I Special

For tennis courts and sports grounds. Working width 90 cm, empty weight 60 kg, water filled 180 kg. Single-piece roller body with rounded edges and counter weights.

**No. 40170**

## Manual roller I

Like article No. 40170, but without counter weights.

**No. 40171**

## Manual roller II Special

Like article No. 40170, but with a split roller body which makes it easier to turn.

**No. 40180**

## Manual roller II

Like article No. 40180, but without counter weights.

**No. 40181**



# Maintenance Equipment



## Turbo Broom USP 10

The Turbo Broom USP 10 makes it easier to remove the old clay in spring. Through the low empty weight, the broom is to move effortlessly. The V-belt drive enables a left/right run, which makes it possible to remove the corners of the tennis court neatly. The Turbo Broom USP 10 is variously usable, so it is also possible to use that machine to remove leaves and snow from paths and car parks.

### Technical data:

- Motor: Honda, 4-stroke, 4 kW/5 PS
- Drive: by hand
- Kehrbesenantrieb: V-belt drives left/right
- Working width: ca. 90 cm
- Tyres: balloon tyres
- Weight: 65 kg
- Time requirement: ca. 40 min. per court

**No. 40161**

### Accessories

- No. 40165** PVC bristles, double, white (without illustration)
- No. 40164** Steel/PVC bristles
- No. 40162** Swath former



## Turbo-Broom USP 800

This new turbo-broom is developed to remove soiled clay in spring much faster and more easily. In contrast to the original turbo-broom it is equipped with a self-powered drive and brush-system with a hydraulic, hydrostatic Honda 4.4 kW engine. Both drives are easy to handle through the easy-to-read control board. PVC bristles are the same high quality as those with the USP 20 broom. Broom height can be adjusted to the millimeter without tools by using a crank at the broom frame. The continued usage of the hydrostatic drive guarantees easy and precise work and a long life with little maintenance.



### Technical Data:

- Motor: Honda, 4-stroke, 4 kW/6 PS
- Drive: hydrostatic
- Sweeping broom: hydrostatic, left/right
- Working width: ca. 90 cm
- Tyres: balloon tyres
- Weight: 100 kg
- Time requirement: ca. 20 min. per court

**No. 40143**



### Accessories

- No. 40145** PVC bristles (standard equipment), yellow
- No. 40147** Steel bristles
- No. 40148** Swath former

# Line Tapes - Accessories

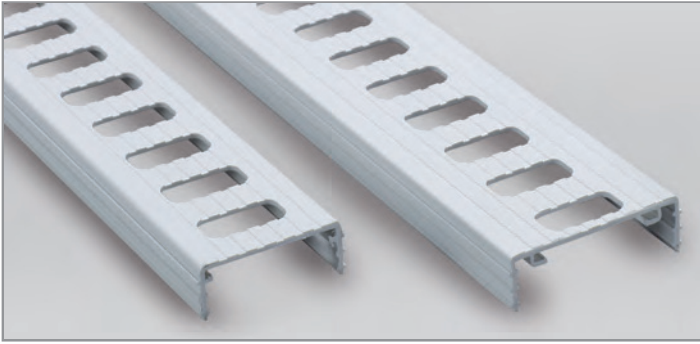

## Marking Strips with Perforations, Universal

Simple installation without nails. Non-slip surface, excellent ball bounce behavior. Set consists of 85 lengths 4 cm wide, 8 lengths 5 cm wide, each 1.60 m long. Complete with connectors. Complying with international regulations.

**No. 40290** 4 + 5 cm

**No. 40291** 93 lengths 5 cm

## Marking Strips unperforated

**No. 40250** white, 4 + 5 cm



## Replacement Marking Strips with Perforations

Complete with connectors. Set of 10 lengths, each 1.60 m

**No. 40292** 4 cm

**No. 40293** 5 cm

## T-connectors

100 per set

**No. 40301**

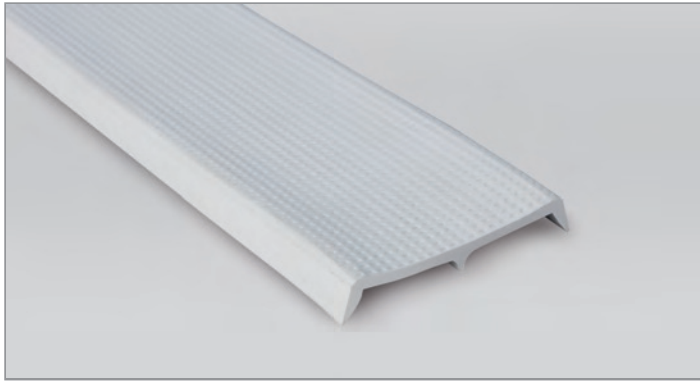

## Marking Line I

Installation requires only a few nails (nails not included). Set consists of 3 rolls, each roll 50 m.

**No. 40200** 4 cm

Only available in complete sets.



## Fastening Nails

Rounded, flat-head, hot-dip galvanized. Specially made for tennis lines. 5 kg required for each court.

**No. 40310**

## Treated Wooden Pegs

For securing the corner points. 16 pegs required for each tennis court.

**No. 40330**

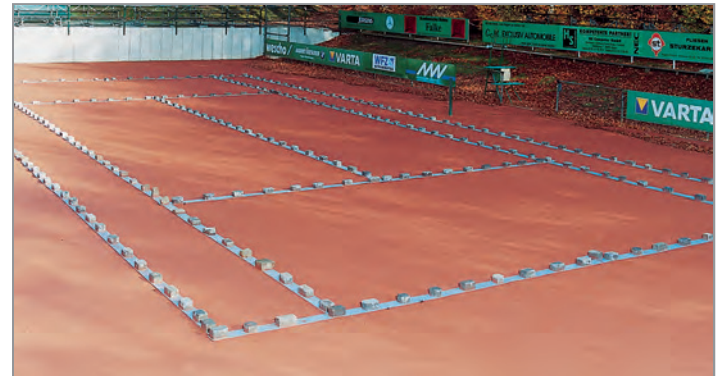

## Iso-Line

Anti-frost line covering. Protection against frost and other extreme weather conditions. Polyethylene 150 mm wide, 8 mm thick, set consists of three rolls, each 50 m. The tape should be weighted down with stones every 30 cm.

**No. 40341**



# Line Tapes - Accessories

## Tennis Line Speziala / Court Plus

This tennis line has been developed especially for clay courts. Made of flexible, hard, grooved PVC. With 4 mm wide lateral slits, at 28 mm intervals. The lines for double courts are supplied in 6 rolls. Hard PVC and lateral slits allow the lines and court surface to interlock perfectly. The lines are anchored with 18 ground plugs per court, which are included with all line sets. The installation of the lines can be carried out by only 1 person. Please choose the lines with the appropriate anchoring set for your needs.



### Ratchet Tensioner

Galvanized tensioner with special belts.  
No. 40371



### Drive-in Peg for Anchor Tube

Made of steel. In order to avoid damages while bashing the ground anchors, it is highly recommendable to use the drive-in-peg for anchor tubes.  
No. 40376

### Anchor Tube Ground Plug

No. 40373

**Anchor Tube Floor Dowel** made from stainless steel  
No. 403730

## Tennis Line Speziala I / Court Plus I

Includes 18 anchor tube ground plugs  
4 rolls, each 24 m – 4 cm width / 1 roll, 22 m – 4 cm width / 1 roll, 17 m – 4 cm width / 1 roll, 13 m – 5 cm width  
No. 40365

## Tennis Line Speziala II / Court Plus II

Includes 18 anchor tube ground plugs  
4 rolls, each 24 m – 4 cm width / 1 roll, 22 m – 5 cm width / 1 roll, 30 m – 5 cm width  
No. 40366

## Tennis Line Speziala III / Court Plus III

Includes 18 anchor tube ground plugs  
4 rolls, each 24 m – 5 cm width / 1 roll, 22 m – 5 cm width / 1 roll, 30 m – 5 cm width  
No. 40367

## Speziala 40 mm - Replacement Roll

No. 40374 17 m roll

No. 403740 22 m roll

No. 403741 24 m roll

## Speziala 50 mm - Replacement Roll

No. 40375 13 m roll

No. 403750 22 m roll

No. 403752 24 m roll

No. 403751 30 m roll

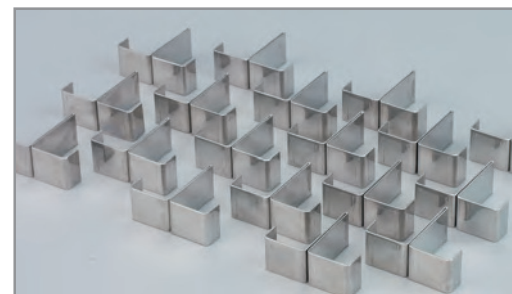

## Court Plus Anchoring Set

Consists of: 18 fixing clamps, rust-proof  
No. 403530

## Fixing Clamps

Made from stainless steel. For better anchorage of the corners. Fits to all Speziala sets.  
No. 40353



## Speziala Anchoring Set I

Consists of: 18 stainless steel tubular anchors, 16 pieces with 4 cm anchors and 2 pieces with 5 cm anchors.  
No. 403760

## Speziala Anchoring Set II

Consists of: 18 stainless steel tubular anchors, 8 pieces with 4 cm anchors and 10 pieces with 5 cm anchors.  
No. 403761

## Speziala Anchoring Set III

Consists of: 18 stainless steel tubular anchors, 18 pieces with 5 cm anchors.  
No. 403762

## Tubular Anchor

No. 40372

## End Fastener

No. 40358 4 cm

No. 40359 5 cm

# Line Tapes - Accessories



## Line Stamper

Made of plastic coated steel. Heavy duty design to stamp in the marking lines, weight 5 kg.  
**No. 40380**



## Line Stamper 2

Made of steel, plastic coated with flexible shock absorber to stump in the marking lines. Weight 5 kg  
**Nr. 40381**



## Line Roller

This roller is ideally suited for rolling in tennis court lines. The heavy weight of approx. 65 kg and the roller width of 10 cm ensures that the line is pressed in quickly and neatly. No stamping required.  
**No. 40384**



## Marking Trolley for Tennis

New product developed for children's tennis, spreading width approx. 50 mm.  
**No. 45005**

## Chalk for Tennis Courts

5 kg. in pail  
**No. 45009**



## BMI Steel Tape Measure

Body, galvanized steel with plastic covering. Steel tape 13 mm wide.

- No. 10584** 10 m
- No. 10585** 20 m
- No. 10586** 30 m
- No. 10587** 50 m

## Distance Measure Rollfix-Easy

Sturdy construction with foldaway frame. Measure area 9999.9 m. Overall height 96 cm, wheel diameter 318.5 mm = 1 m circuit.  
**No. 10590**





# Nets - Posts - Accessories



## Tennis Net Post Alu TP 73

Round post  $\varnothing$  73 mm made of green plastic-coated aluminium. Special profile with three compartments, very sturdy with screw-on gear wheel mechanism of aluminium. Net holding rod and all screws and hooks are made of VA steel. Delivery without ground sleeves.  
**No. 40422**

## Gound Sleeves 73

Ground sleeves for 73  $\varnothing$  mm post.  
**No. 404281**

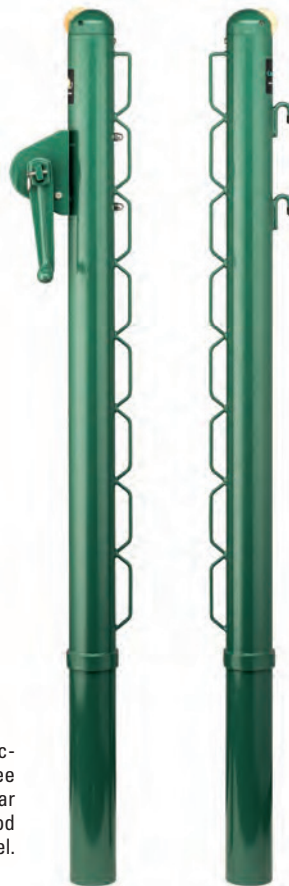

## Tennis Net Post Steel TP 76

Round post  $\varnothing$  76 mm made of green plastic-coated steel pipe with screw-on aluminium gear wheel mechanism with brass rope castors. removable crank, net-holding straps and net hooks fully welded. Delivery without ground sleeves.  
**No. 40427**

## Gound Sleeves 76

Ground sleeves for 76  $\varnothing$  mm post.  
**No. 40428**



## Tennis Net Post USA, Steel 76

76 mm galvanized  $\varnothing$  steel, green powder-coated. With brass gear mechanism, stringing block and a removable crank. Ground sleeves not included. Meets the European DIN EN 1510 safety standard.  
**No. 40425**

## Gound Sleeves 76

Ground sleeves for 76  $\varnothing$  mm post.  
**No. 40428**



## Tennis Net Post USA, Steel 80

80 x 80 mm galvanized steel, green powder-coated. With brass gear mechanism, stringing block and a removable crank. Ground sleeves not included. Meets the European DIN EN 1510 safety standard.  
**No. 40424**

## Gound Sleeves 80 x 80

Ground sleeves for 80 x 80 mm post.  
**No. 40433**



# Nets - Posts - Accessories



## Tennis Net Post Court Royal TP 83

Round post, Ø 83 mm. Special reinforced aluminum profile with groove for fastening the net holding rod. Internal trapeze tensing mechanism with an aluminium key for easy net tensing. Clip-on cap made of cast aluminium including safety chain. Overall length of posts: 142 cm. Weight: 10.5 kg. Aluminium ground sleeves, depth of insertion 35 cm, complete with cast aluminium cover. Meets the European DIN EN 1510 safety standard.

**No. 40400** aluminium anodized

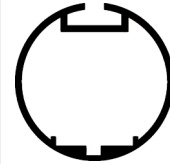

**No. 40410** green powder-coated



**No. 40411** white powder-coated



**No. 40447** black powder-coated



# Nets - Posts - Accessories



## Tennis Net Post Court Royal TP 80

Square post, 80 x 80 mm. Special reinforced aluminium profile with groove for fastening the net holding rod. Internal trapeze tensioning mechanism with aluminium key for easy net tensioning. Clip-on cap made of cast aluminium including safety chain. Overall length of posts: 142 cm. Weight: 10.5 kg. Aluminium ground sleeves, depth of insertion 35 cm, complete with cast aluminium cover. Meets the European DIN EN 1510 safety standard.

**No. 40430** aluminium anodized

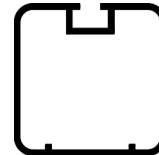

**No. 40440** green powder-coated



**No. 40445** white powder-coated



**No. 40446** black powder-coated



**No. 40448** blue powder-coated

# Nets - Posts - Accessories



## Collapsible Tennis Net Post Court Royal

This is the post to use if ground sleeves are not possible. To be fastened with a 10 mm steel dowel and a screw. 80 x 80 mm aluminium post. Held on a reinforced steel base with front support. Royal post design. **No. 40470**



**Mechanics made of Brass 76** (1.) for Tennis Net Post USA Steel 76, complete with fastening screws. **No. 404251**

**Mechanics made of Brass 80** (2.) for Tennis Net Post USA Steel 80, complete with fastening screws. **No. 404241**

**Crank made of Brass** for mechanics Tennis Net Post USA Steel 76 und 80. **No. 404242**

**Crew made of Brass** for crank Tennis Net Post USA Steel 76 und 80. **No. 404243**



## Mechanic for Tennis Posts

This winding gear mechanism can be attached with 2 M8 screws at each post. Holes pre-drilled and M8 thread cut. **No. 40429**



## Spare parts for tennis net posts

- 1. Ground sleeve 80 x 80 mm **No. 40431**
- 2. Ground sleeve 83 mm Ø **No. 40401**
- 3. Cover for ground sleeve 80 x 80 mm **No. 40450**
- 4. Cover for ground sleeve 83 mm Ø **No. 40420**
- 5. Tensioning mechanism **No. 40405**

- 6. Key for tensioning mechanism **No. 40404**
- 7. Net holding rod **No. 40402**
- 8. Set of screws, eight eye bolts, eight groove sliding blocks and two net hooks **No. 40403**
- 9. Cap for blind post 80 x 80 mm **No. 40416**
- 10. Cap for mechanism post 80 x 80 mm **No. 40415**

- 11. Cap for blind post 83 mm Ø **No. 40407**
- 12. Cap for mechanism post 83 mm Ø **No. 40406**  
Please indicate color with items 9 - 12
- 13. Net repair cord 3 mm, 20 m long, 3 mm black **No. 40653**  
3 mm green **No. 40654**



# Nets - Posts - Accessories



## Tennis Net System Court Royal II Tournament

This newly developed tennis net system is a unique top-class product ; it differs from conventional systems through simple modification from double court measurements to single court measurements. Will be delivered in 5 parts. For single court usage the middle part has to be removed and a single net has to be mounted. Delivery is without net, single net rods and center strap. Here we recommend tennis net Court Royal TN50 No. 40565 (page 23) for doubles and tennis net Court Royal TN55 No. 40566 for single as well as Center Strap II No. 40710 (page 24), weight: 165 kg.

**No. 40485**



**Tennis Net System Court Royal modified for singles match**



**Additional Weights for ATP-tournaments and Davis-Cup**

**No. 404901** (1 set has 4 weights à 10 kg)



**Single Net Rods Special** for Tennis Net System Court Royal  
**No. 404902**



**Tennis Net System Court Royal with mounted weights**





# Nets - Posts - Accessories



## Tennis Net Court Royal TN 8

Made of 3.2 mm braided polyethylene, hand-knotted, black, stable polyester net enclosure stitched four times, complete with steel wire. DIN EN 1510. With European Seal of Approval.

**No. 40549** black



## Tennis Net Court Royal TN 9

Made of 3.4 mm braided polyethylene, hand-knotted, black, stable polyester net enclosure stitched 6 times, complete with plastic-coated steel cable. Sides and bottom with heavy, black plastic edging as well as two 10 mm strong fiberglass rods for lateral fixing. Long-lasting and very durable. 3 years factory warranty on the netting. DIN EN 1510. With European Seal of Approval.

**No. 40545** black



## Tennis Net Court Royal TN 15 black

Made of 3.2 mm braided polyethylene, black, hand-knotted, the upper 6 rows double-knotted, stable polyester net enclosure stitched 4 times. A super tennis net, long-lasting, good quality. Complete with steel wire. DIN EN 1510. With European Seal of Approval.

**No. 40550** black



## Tennis Net Court Royal TN 15 green

Made of 3.2 mm braided polyethylene, green, hand-knotted, the upper 6 rows double-knotted, stable polyester net enclosure stitched 4 times. A super tennis net, long-lasting, good quality. Complete with steel wire. DIN EN 1510. With European Seal of Approval.

**No. 40552** green



## Tennis Net Court Royal TN 20 black

Made of 3.4 mm braided polyethylene, black, hand-knotted, the upper 6 rows double-knotted, stable polyester net enclosure stitched four times. 1000 times proven, classic tennis net. Used in the tennis league, ATP-tournaments, Davis-Cup, as well as in the Olympics. A top-class product. Complete with steel wire. 2 years factory warranty on the netting. DIN EN 1510. With European Seal of Approval.

**No. 40560** black



## Tennis Net Court Royal TN 20 green

Made of 3.4 mm braided polyethylene, black, hand-knotted, the upper 6 rows double-knotted, stable polyester net enclosure stitched four times. 1000 times proven, classic tennis net. Used in the tennis league, ATP-tournaments, Davis-Cup, as well as in the Olympics. A top-class product. Complete with steel wire. 2 years factory warranty on the netting. DIN EN 1510. With European Seal of Approval.

**No. 40570** green





# Nets - Posts - Accessories



## Tennis Net Court Royal TN 90 black

Made of 3.8 mm braided polyethylene, hand-knotted, the upper 6 rows double-knotted, stable polyester net enclosure stitched four times, complete with plastic-coated steel cable. Sides and bottom with heavy, black plastic edging, as well as 10 mm strong fiberglass rods for lateral fixing. Long-lasting and very durable. A tennis net in a special class. 3 years factory warranty on the netting. DIN EN 1510. With European Seal of Approval. Used in the tennis league, ATP tournaments, Davis Cup, as well as in the Olympics.

**No. 40610** black



## Tennis Net Court Royal TN 90 green

Made of 3.8 mm braided polyethylene, hand-knotted, the upper 6 rows double-knotted, stable polyester net enclosure stitched four times, complete with plastic-coated steel cable. Sides and bottom with heavy, black plastic edging, as well as 10 mm strong fiberglass rods for lateral fixing. Long-lasting and very durable. A tennis net in a special class. 3 years factory warranty on the netting. DIN EN 1510. With European Seal of Approval. Used in the tennis league, ATP tournaments, Davis Cup, as well as in the Olympics.

**No. 40611** green



## Tennis Net Court Royal TN 30

Made of 3.8 mm braided polyethylene, hand-knotted, the upper 7 rows double-knotted, stable polyester net enclosure stitched 6 times, complete with plastic-coated steel cable. Sides and bottom with heavy, black plastic edging as well as two 10 mm strong fiberglass rods for lateral fixing. Long-lasting and very durable. 3 years factory warranty on the netting. DIN EN 1510. With European Seal of Approval.

**No. 40548** black



## Deluxe Tennis Net Court Royal TN 200

Made of 5mm polyethylene with PVC covering. Very strong headband and borders. This net is also noted for its extremely long lifespan. Includes steel wire.

**No. 40580** black



## Tennis Net Court Royal TN 50 Tournament

Made of 3.5 mm braided polyethylene. Hand-knotted, the upper 7 rows double-knotted, very stable polyester net enclosure stitched four times. Complete with plastic-coated steel cable. 2 years warranty on the netting. Mesh size 4 cm, prevents balls becoming stuck in the net. DIN EN 1510. With European Seal of Approval.

**No. 40565** black

## Measuring Rod

Aluminum tube with marking at net height 91.5 cm

**No. 40652**

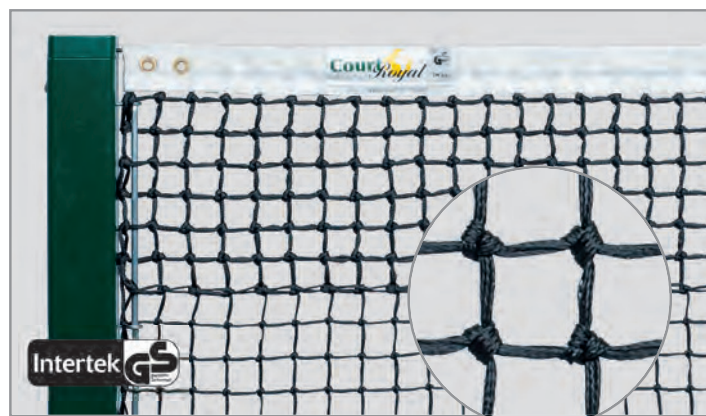

## Tennis Net Court Royal TN 55 Tournament Singles

Made of 3.5 mm braided polyethylene. Hand-knotted, the upper 7 rows double-knotted, very stable polyester net enclosure stitched four times. Complete with plastic-coated steel cable. 2 years warranty on the netting. Mesh size 4 cm, prevents balls becoming stuck in the net. DIN EN 1510. With European Seal of Approval.

**No. 40566** black



# Nets - Posts - Accessories



**Center Strap I**  
Made of cotton fabric, with brass eyes.  
**No. 40700**



**Center Strap II**  
Made of PVC, with adjustable loops and spring hooks.  
**No. 40710**



**Center Strap III**  
With plastic snap lock, spring hook and Velcro strip.  
**No. 40720**



**Center Strap IV**  
With Velcro closure.  
**No. 40711**



**Universal Center Strap**  
Made of high-strength nylon with stainless steel buckles and special hooks.  
**No. 40690**



**Tennis Net Hanging Bracket**  
For winding and storage of tennis nets. Ready for use at any time.  
**No. 40551**



**Tennis Net Numbering**  
Red plates made out of plastic, 30 mm diameter, with white numbers and snap hook to fix it to the tennis net for easy identification of courts.

- No. 40553** Set of 6
- No. 40554** Set of 12
- No. 40556** Set of 18

# Nets - Posts - Accessories



**1) Tennis Net Weight**

Made of steel pipe with suspension eye for strap.  
**No. 40721**

**2) Ground Anchor I**

Made of stainless steel.  
**No. 40740**

**3) Ground Anchor Submerged Tube**

Made of aluminium for indoor and all-weather courts.  
**No. 40760**

**4) Tensioning Screw**

Made of galvanized iron, with counter nut.  
**No. 40730**

**5) Ground Anchor Special**

Steel wire with 3 mm eye loop for attachment.  
Anchors when secured in the ground.  
**No. 40751**

**6) Ground Anchor II**

Galvanized to hammer in, easy to use.  
**No. 40750**

**7) Ground Anchor III**

U-shaped, galvanized.  
**No. 40755**



**Replacement Tennis Net Headband**

Fast to replace, complete with looping string.  
**No. 40670**

**Replacement Wire** with loops, 13.80 m long.  
**No. 40660**



**Single Net Rods**

To use for single tournament games. Made of aluminium.

**No. 40650** unpainted

**No. 40649** white

**No. 40648** green

**No. 40655** black

**No. 40647** blue



# Scoreboards



## Court Royal Pointer

Scoreboard with 6 adjustable disks for 3 set scores. Scoreboard visible on both sides, improved design makes scores even easier to read. Weather-resistant construction of light-resistant plastic. Easy mounting on fence or net. Supplied complete with mounting brackets. Size: 56 x 80 cm

**No. 40823** white

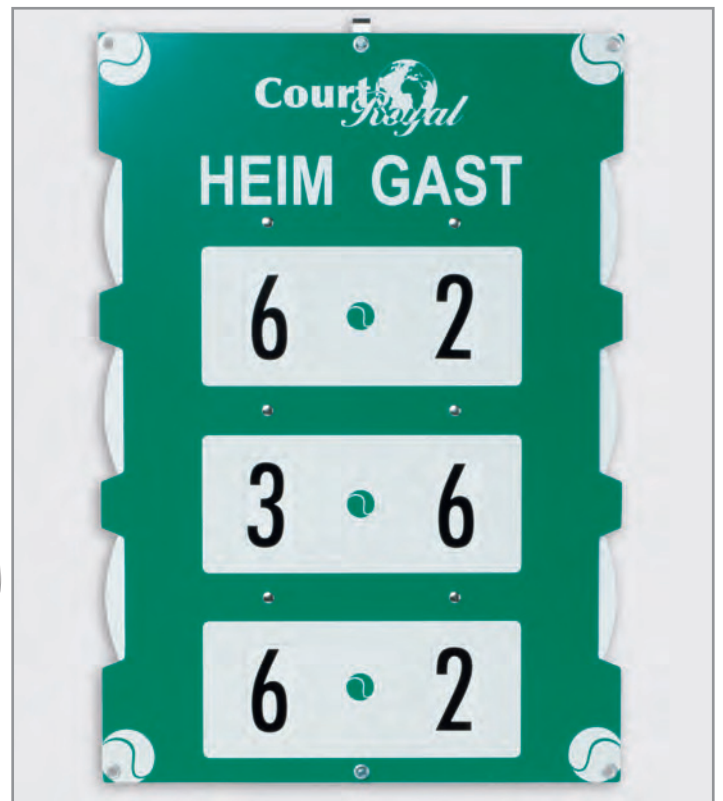

## Court Royal Pointer

Scoreboard with 6 adjustable disks for 3 set scores. Visible on both sides, clearer and easier to read, weather-resistant and light-resistant plastic. Easy mounting on fence or net. Complete with mounting brackets. Size 56x80 cm with 10 cm big digits.

**No. 40824** green



## Court Royal Pointer

Scoreboard with 6 adjustable disks for 3 set scores. Visible on both sides, clearer and easier to read, weather-resistant and light-resistant plastic. Easy mounting on fence or net. Complete with mounting brackets. Size 56 x 80 cm with 10 cm big digits.

**Nr. 40829** blue



## Court Royal Pointer free-standing

Scoreboard with 6 adjustable disks for 3 set scores. Visible on both sides, clearer and easier to read, weather-resistant and light-resistant plastic. Sturdy aluminium stand with large fillable plastic base. Size 56 x 80 cm.

**No. 40831** blue

**No. 40827** white

**No. 40828** green

# Scoreboards



## Match Pointer Scoreboard

With 6 adjustable disks for 3 set scores. Display on front and back. Clearly laid out, easy-to-read design. Sturdy, weather-resistant construction from light-resistant plastic and rust-proof hardware. Easy mounting on fence or net, complete with fence mount. International version: Local/Visit

### Model Super Big international

Size: 65 x 96 cm  
with 12 cm high numbers  
No. 408151

### Model Big International

Size: 46 x 65 cm  
with 8 cm high numbers  
No. 408161

### Model Super international

Size: 56 x 80 cm  
with 10 cm high numbers  
Nr. 408141

### Model Little International

Size: 35 x 50 cm  
with 6 cm high numbers  
No. 408171



## Match Pointer Scoreboard Free-Standing

With 6 adjustable disks for 3 set scores. Display on front and back. Clearly laid out, easy-to-read design. Sturdy, weather-resistant construction from light-resistant plastic and rust-proof hardware. Sturdy aluminium stand with support bar and fillable plastic foot.

### Model Big International

Size: 46 x 65 cm, with 8 cm high numbers  
No. 408183

### Model Super Big International

Size: 65 x 96 cm, with 12 cm high numbers  
No. 408192

### Spare number disks

One set contains 6 disks

No. 40811 Model Little 6 cm numbers  
No. 408110 Model Big 8 cm numbers  
No. 408115 Model Super 10 cm numbers  
No. 408111 Model Super Big 12 cm numbers



## Scoreboard Umpire Chair

To mount on all umpire chairs. Display on front and back. The umpire flips over a card after each game. Complete with mounting hardware.  
No. 40830



## Scoreboard

This practical scoreboard is simply placed over the net. The numbers are flipped over to show the score from both sides.  
From 0 – 9, size 11 cm, incl. bag.  
Size: 15 x 18 cm  
No. 40835



# Umpire Chairs



## Advertising Umpire Chair Court Royal Deluxe Grand Slam

This heavy duty chair is ideal for advertising with 2 side panels of 10 mm PVC and 3 mm panels between steps. Plastic-coated aluminium base with UV-resistant seat and PVC table. Supplied without advertising. Supplied in standard color white, also available in green or other RAL colors on request.

**No. 408101** white

### 4-color digital printing

Please provide file for printing.

**No. 407934**



## Advertising Umpire Chair Court Royal Deluxe Grand Prix

Plastic coated aluminium chair with UV-resistant seat and PVC table, ideal for advertising. Base frame with two side panels of 10 mm PVC. Supplied without advertising. Supplied in standard color white, also available in green or other RAL colors on request.

**No. 408100** white

### 4-color digital printing

Please provide file for printing.

**No. 407941**



## Umbrella for Umpire Chair

Solid, tiltable parasol with a diameter of 150 cm, red. Including fittings.

**No. 408005**



## Seat Court Royal

**No. 408148** green

**No. 408150** red

**No. 408149** white

**No. 408147** blue



## Seat, red

**No. 40771**



## Writing board

white, 550 mm x 15 mm x 10 mm.

**Nr. 408097**



# Umpire Chairs



## Umpire Chair Court Royal Tournament

Elegant aluminium umpire chair with European Seal of Approval DIN EN 131. Very robust because of the stable ladder and the projecting supports with four base plates. The seat mount has an extra crossbar behind the red, UV-resistant body-contoured seat.

**No. 40800**



## Umpire Chair Court Royal Deluxe

This aluminium umpire chair with European Seal of Approval DIN EN 131, meets the highest standards. The ladder with its especially wide slip-proof rungs, as well as the projecting supports with four base plates, gives this chair optimum stability. The middle plate between the ladder and the supports provides extra durability. The seat mount has an extra crossbar behind the red, UV-resistant body-contoured seat.

**No. 40809**



## Umpire Chair Court Royal Deluxe powder-coated

Same features as model No. 40809, green, white or blue powder-coated, with green, white or blue seat.

**No. 408099** green

**No. 408098** white

**No. 408089** blue

# Benches



**Players Bench Grand Slam Aluminium** 150 cm long, white.  
The bench is an ideal advertising medium and is used worldwide at international tennis tournaments and in football stadiums. High-quality aluminium construction, white powder-coated. The seating surface consists of 5 multi-chamber profile slats, supplied in four parts, easy assembly. The 10 mm PVC advertising panels are pre-assembled without an advertising logo. Weight 27 kg.  
**No. 41222**

**4-color digital printing.** Please provide file for printing.  
**No. 412221**

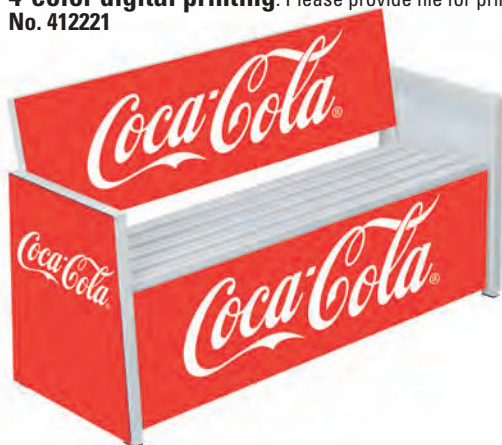

**Front Advertising Panel 150 cm**  
Additional advertising panel for the front leg area. 10 mm PVC advertising panel with aluminium mounting bar and fittings as well as a 6 mm drill to pre-drill the holes for the self-tapping screws. Easy handling according to instructions.  
**No. 412223**

**4-color digital printing** Please provide file for printing.  
**No. 412225**

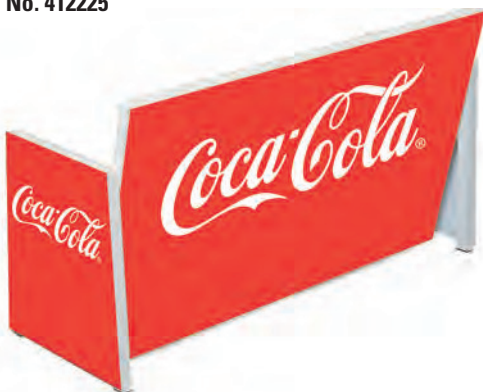

**Rear Advertising Panel 150 cm**  
Additional advertising panels for the rear of the bench. 10 mm PVC advertising panels, pre-drilled, with fittings as well as a 6 mm drill to drill the holes for the self-tapping screws. Easy handling according to instructions.  
**No. 412224**

**4-color digital printing**  
Please provide file for printing.  
**No. 412226**



**Umbrella**  
for advertising bench.  
Solid, tiltable parasol with a diameter of 150 cm, various colours available.  
**No. 408009**



**Umbrella Holder** for advertising bench.  
Made of white, powder-coated aluminium, with fittings for easy mounting.  
**No. 408007**



**Advertising Bench Freiburg KU 150 cm**  
2 all-plastic legs and 5 multi-chamber plastic slats serving as a seat and a KU backrest for easy attachment of advertising stickers. The more economical model is developed especially for indoor use as well as for Central European temperatures.  
**No. 41202** white



**Advertising Bench Freiburg GFK 150 cm**  
2 all-plastic legs and 5 multi-chamber plastic slats serving as a seat and a KU backrest for easy attachment of advertising stickers. This exclusive, high-quality GFK model is very robust and specially developed for extremely hot regions.  
**No. 41208** white

**4-color digital printing**  
Please provide file for printing.  
**No. 412209**



# Benches



## Deluxe Tennis Bench

Our newly designed tennis court bench has everything you could wish for. Plenty of space (approximately 100 x 45 cm) in the middle for bags and rackets, two comfortable seats, with plastic-, weather- and light-resistant seat pads, 57 cm wide and 50 cm deep. Super robust design. A first class product.

**No. 41213** white



## Bench Hohenzollern

Elegant, yet extremely robust bench for tennis courts and outdoor use. With armrests, seat width 150 cm, seat depth 50 cm. Solid plastic construction with integrated, stainless steel brackets. Seat and back are supplied preassembled to make setting up easier.

**No. 412012** white



## Landhaus planter

Solid plastic construction. Internal capacity 40 x 40 cm split into four side parts, supplied with bottom tray.

Footprint 46 x 46 x 46 cm.

**No. 412013** white



## Bench Cologne 120 cm long, white

2 plastic legs and 9 multi-chamber plastic slats, foldable. Proven high-quality. Weight approx. 13 kg.

**No. 412233**



## Bench Cologne 120 cm long, green

2 plastic legs and 9 multi-chamber plastic slats, foldable. Proven high-quality. Weight approx. 13 kg.

**No. 412234** green



# Benches



**Bench Munich** 150 cm long, white  
2 plastic legs and 5 multi-chamber plastic slats, without backrest and therefore usable from both sides. Practical and comfortable to sit on. Weight approx. 9 kg.  
**No. 412210** white

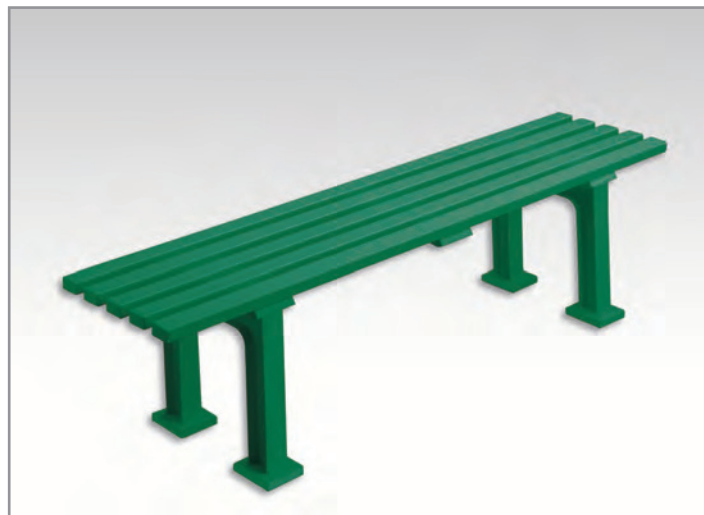

**Bench Munich** 150 cm long, green  
2 plastic legs and 5 multi-chamber plastic slats, without backrest and therefore usable from both sides. Practical and comfortable to sit on. Weight approx. 9 kg.  
**No. 412211** green



**Bench Freiburg** 150 cm long, white  
2 plastic legs and 9 multi-chamber plastic slats with reinforcement bracket in the center, foldable. Proven high-quality. Weight 15,5 kg.  
**No. 41200** white



**Bench Freiburg** 150 cm long, green  
2 plastic legs and 9 multi-chamber plastic slats with reinforcement bracket in the center, foldable. Proven high-quality. Weight 15,5 kg.  
**No. 41199** green



**Bench Helgoland** 150 cm long, white  
2 plastic legs and 12 multi-chamber plastic slats with reinforcement bracket in the center, foldable. Practical and comfortable to sit on. Weight approx. 19 kg.  
**No. 41203** white



**Bench Helgoland** 150 cm long, green  
2 plastic legs and 12 multi-chamber plastic slats with reinforcement bracket in the center, foldable. Practical and comfortable to sit on. Weight approx. 19 kg.  
**No. 41207** green

# Benches

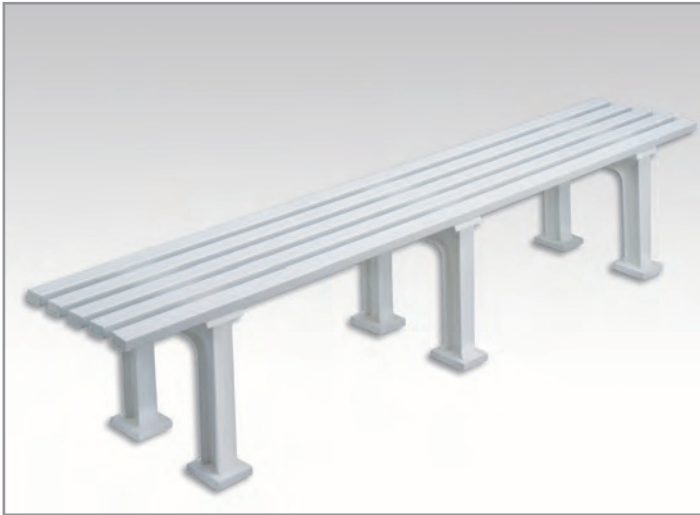

**Bench Stuttgart** 200 cm long, white  
3 plastic legs and 5 multi-chamber plastic slats, without backrest therefore usable from both sides. Practical and comfortable to sit on. Weight approx. 11,5 kg.  
**No. 412212** white

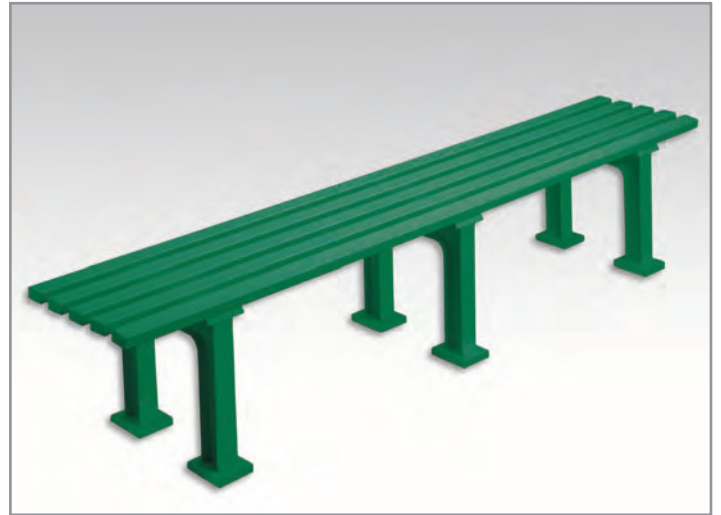

**Bench Stuttgart** 200 cm long, green  
3 plastic legs and 5 multi-chamber plastic slats, without backrest therefore usable from both sides. Practical and comfortable to sit on. Weight approx. 11,5 kg.  
**No. 412213** green



**Bench Berlin** 200 cm long, white  
3 plastic legs and 9 multi-chamber plastic slats, foldable. Proven high-quality. Weight 18,5 kg.  
**No. 41210** white



**Bench Berlin** 200 cm long, green  
3 plastic legs and 9 multi-chamber plastic slats, foldable. Proven high-quality. Weight 18,5 kg.  
**No. 41211** green



**Bench Sindelfingen** 200 cm long, white  
3 plastic legs and 12 multi-chamber plastic slats. Practical and comfortable to sit on. Weight approx. 26 kg.  
**No. 41204** white



**Bench Sindelfingen** 200 cm long, green  
3 plastic legs and 12 multi-chamber plastic slats. Practical and comfortable to sit on. Weight approx. 26 kg.  
**No. 41212** green



# Court Treatment Devices

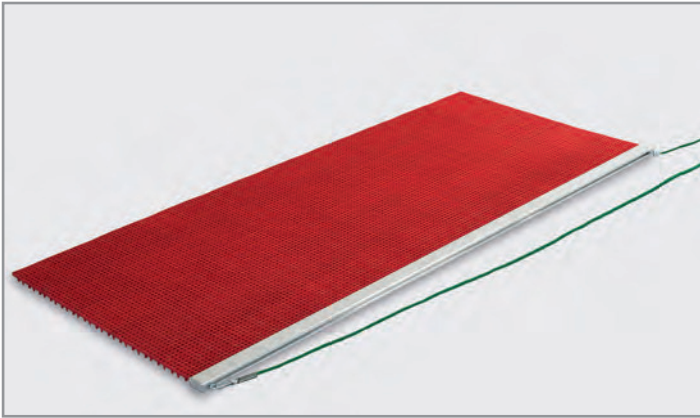

## Hard PVC Smoothing Mat

The newly developed Universal Sport aluminium profile perfects the long-standing concept of the drag mat hard PVC and combiplaner. Due to the 15 x 20 cm individual segments a maximum flexibility of the whole application is given. The manifold scratch elements at the bottom side are ideal for roughening the place and at the same time for smoothing the unevenness and cleaning from leaves without damaging the surface. Especially suited for Cannada -Tennis, artificial grass courts and clay courts. All used material is extremely weather resistant and low wear.

Dimensions: 185 x 75 cm

**No. 41070**

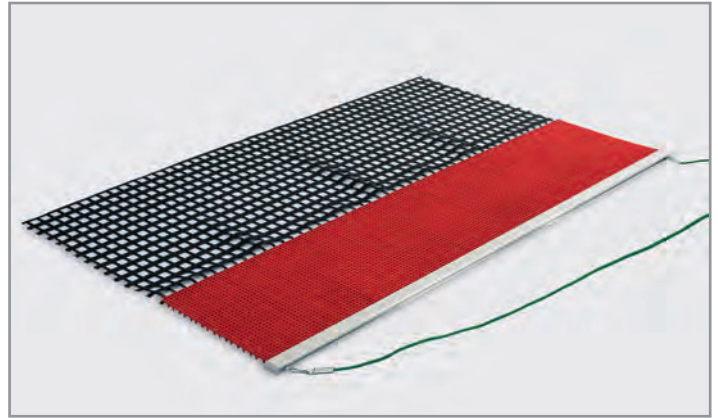

## Combination Leveler

The newly developed Universal Sport aluminium profile perfects the long-standing concept of the drag mat hard PVC and combiplaner. This special tool combines the advantages of the drag mat Hard PVC and that of a drag net. The PVC front part loosens and clears unevennesses and with the rear part of the heavy drag net the open places are smoothed again and scratched filth gets dragged along. All used material is extremely weather-resistant and low-wear. Working width 185 cm

**No. 41079**

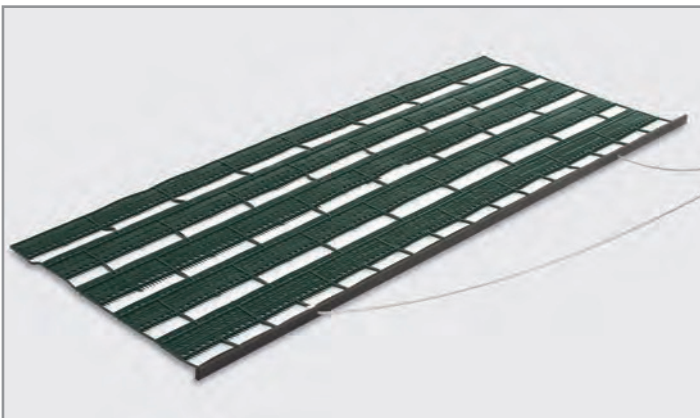
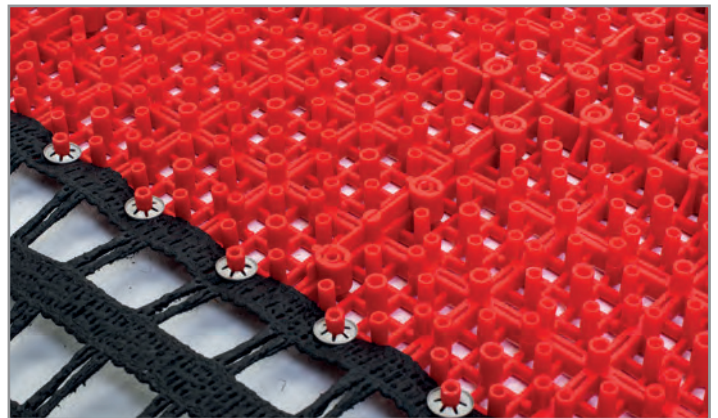
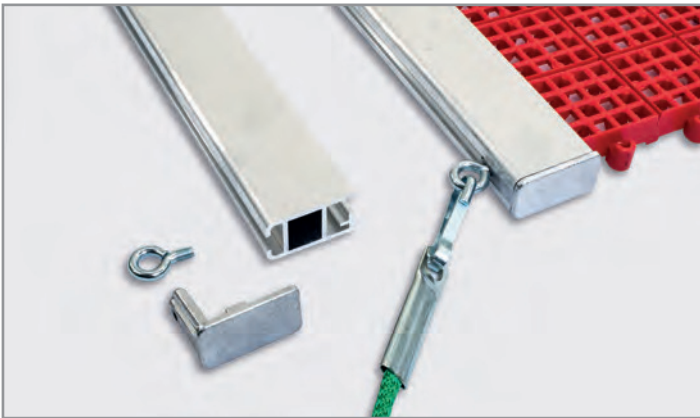

## Smoothing Mat "Super Clean"

This mat was developed to remove foliage, leaves, pine needles, etc. in an effective and quick way. This is possible through the smoothing with the Super Clean drag net which leads to excellent court leveling. After the smoothing a shaking out of the net outside the court is sufficient. The net should be kept flat on the ground while using. Dimensions: 230 x 66 cm.

Includes aluminium rail with drag cord

**No. 41077**





# Court Treatment Devices



## Broom-Mat Platzfit 150

Combination broom and mat. Consists of a broom with plastic bristles and PVC drag net. Aluminium rail and handle.

**No. 41071** working width 150 cm

## Replacement Brushes 150 cm

**No. 410712**

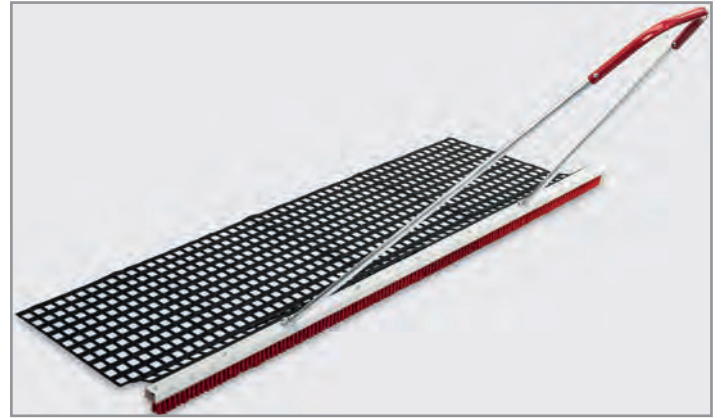

## Broom-Mat Platzfit 200

Combination broom and mat. Consists of a broom with plastic bristles and PVC drag net. Aluminium rail and handle.

**No. 41072** working width 200 cm

## Replacement Brushes 200 cm

**No. 410710**



## Combined Broom

The new Combination broom and net. The top court equipment for clay and granular courts. Consists of a plastic/Arenga broom and PVC special net. Aluminium rail and handle,

**No. 41073** working width 200 cm

## Replacement Brushes 50 cm

**No. 40936**

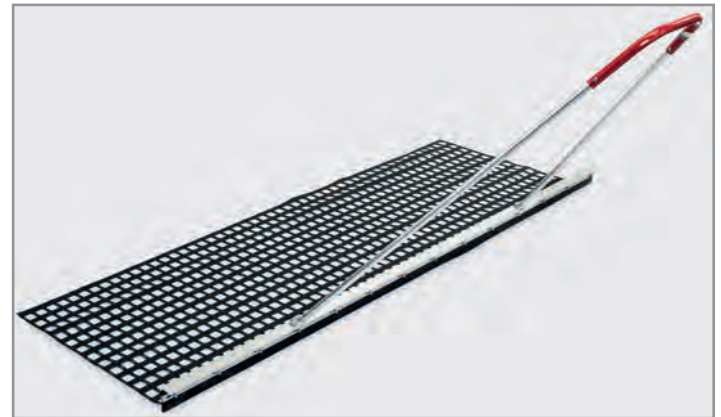

## Combined Hand Leveler

Combination hand leveler and drag net. The ideal tool for smoothing courts after sprinkling or rainfall. Due to the rubber blade and the drag net two operations are done in half the time. Fills unevenness and smoothes the court surface,

**No. 41078** working width 200 cm



## Coconut Smoothing Mat

Heavy-duty coconut mat with PVC edges 200 x 100 cm. Wooden rail with drag cord.

**No. 41060**

## Replacement Smoothing Mat

**No. 41050**

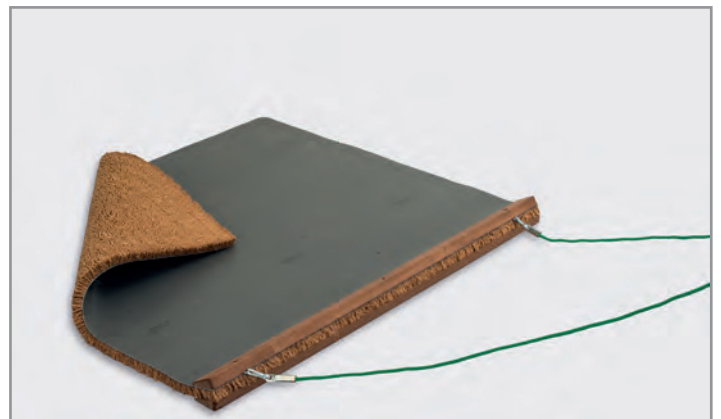

## Special Smoothing Mat for Silica Sand

3 cm long coconut fibers, cast in PVC material. Complete with drag cord.

Size 120 x 90 cm

**No. 40885**

## Replacement Special Smoothing Mat

Size 120 x 90 cm

**No. 40886**



# Court Treatment Devices

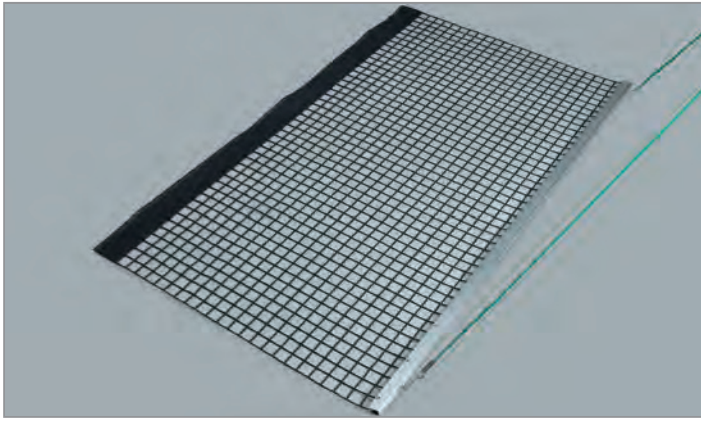

## Aluminium Drag Net, Single PVC

One PVC-coated net 200 x 115 cm, with aluminium rail. Suitable for clay and shale courts.

**No. 40980**

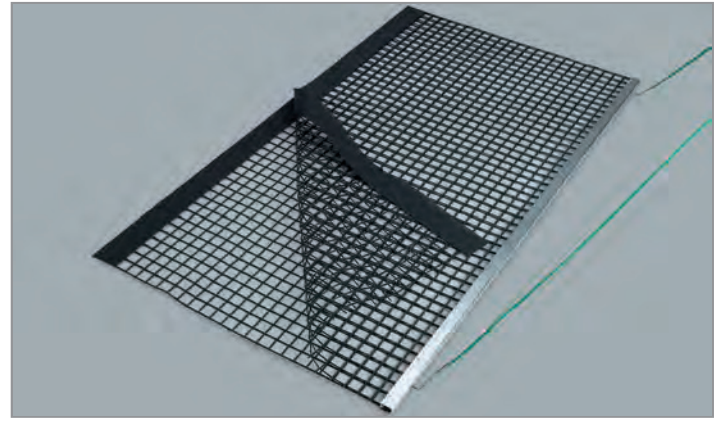

## Aluminium Drag Net, Double PVC

Two PVC-coated nets 200 x 115 cm, with aluminium rail. Suitable for clay and shale courts.

**No. 41010**

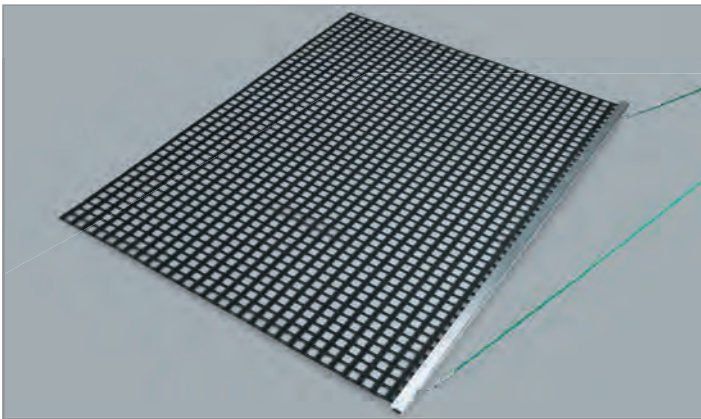

## Aluminium Drag Net, Special Single

One Extra-PVC fabric net with aluminium rail and drag cord. Working width 200cm, depth 150 cm.

**No. 410301**

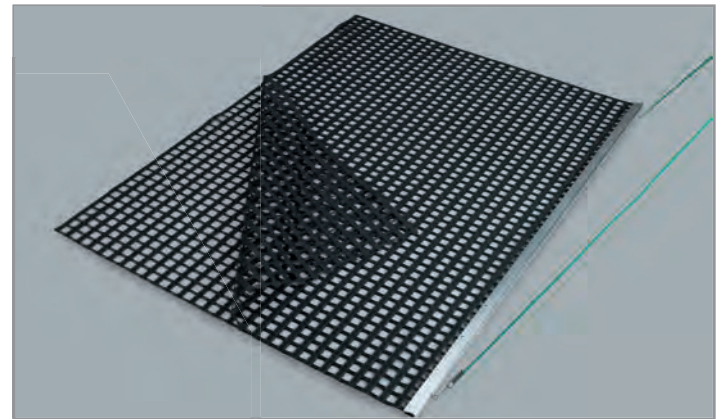

## Aluminium Drag Net, Special Double

Two Extra-PVC fabric nets with aluminium rail and pull-handle. Working width 200 cm, depth 150 cm.

**No. 410302**



## Drag Net Material PVC

Available in rolls 130 x 1.15 m or in pieces 2 x 1.15 m. For drag net self-assembly.

**No. 41001**

## Drag Net Material Extra

Available in rolls 30 x 1.5 m or in pieces 2 x 1.5 m. For drag net self-assembly.

**No. 41031**

## Optiplan with Drag Cord

Black aluminium pull-rod to level courts, PVC extra material. Working width 200 cm, depth 75 cm with drag cord.

**No. 410303**

## Optiplan with Pull-Handle

**No. 410304**



# Court Treatment Devices



## Wooden Drag Net, Single PVC

One PVC-coated net 200 x 115 cm, with wooden rail. Suitable for clay and shale courts.

**No. 41021**

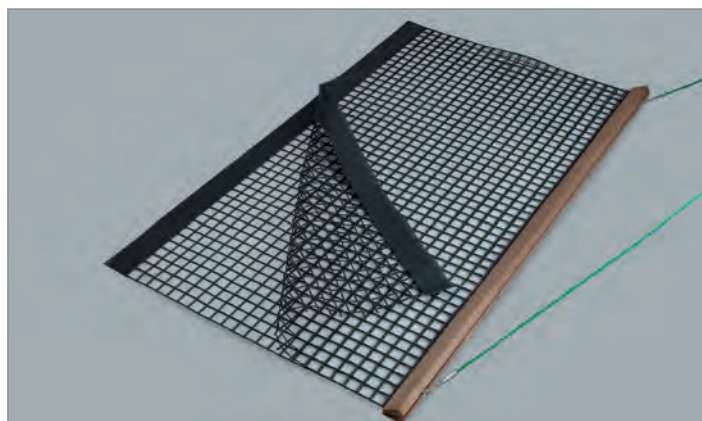

## Wooden Drag Net, Double PVC

Two PVC-coated nets 200 x 115 cm, with wooden rail. Suitable for clay and shale courts.

**No. 41020**

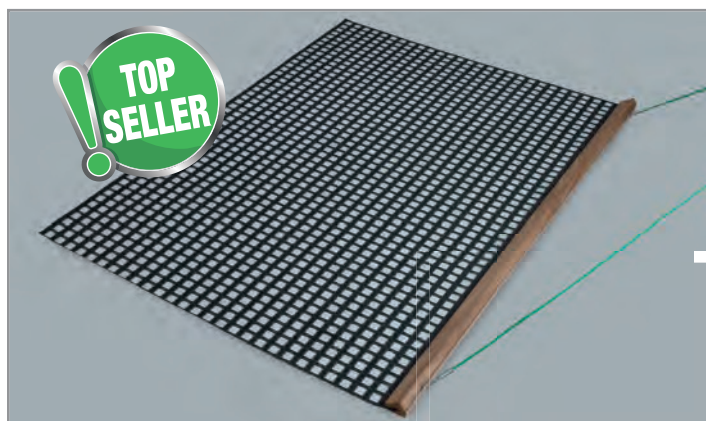

## Wooden Drag Net, Special Single

One special PVC fabric net 200 x 150 cm, with wooden rail. Suitable for clay and shale courts.

**No. 41030**

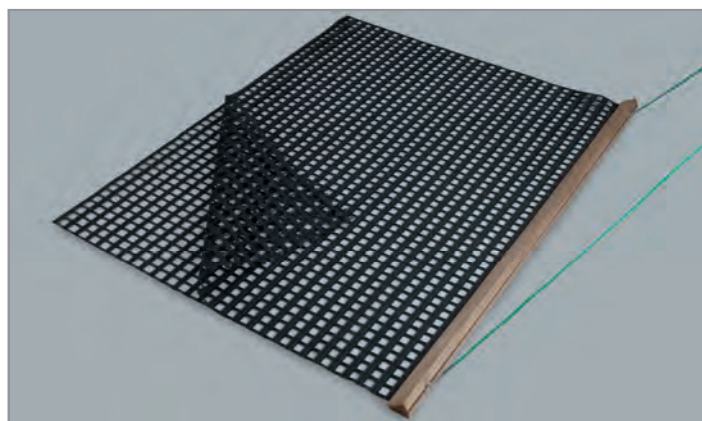

## Wooden Drag Net, Special Double

Two special PVC fabric nets 200 x 150 cm, with wooden rail. Suitable for clay and shale courts.

**No. 41041**



## Wooden Rail

Triangular wood, pre-drilled with screws. 200 cm, complete with drag cord.

**No. 40992**

### Important Information:

Our wooden drag nets are made from torsion-free red pine wood which is not comparable to any other hard wood. Red pine is characterized by its density and durability.

This type of wood is often used in high-quality furniture and patios.

More than 100.000 wooden drag nets have been produced by Universal Sport over recent years.

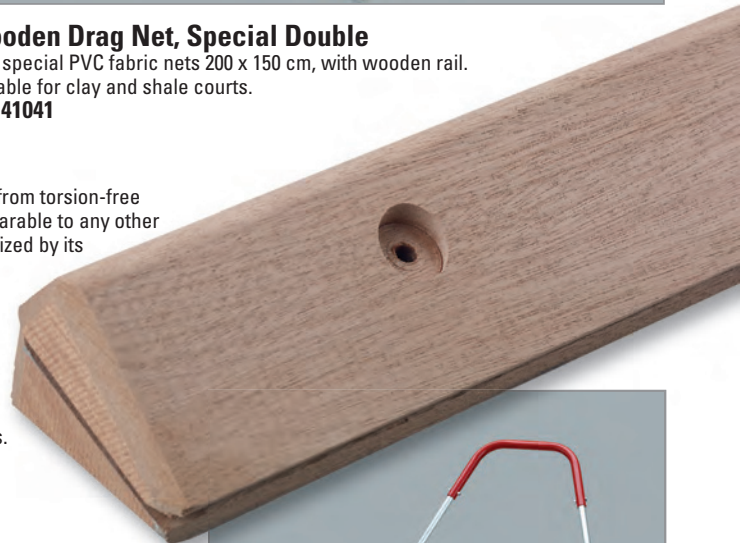

## Aluminium Rail

Width 200 cm, complete with drag cord.

**No. 40990**



## Drag Cord

3.5 m long with spring hooks.

**No. 41002**

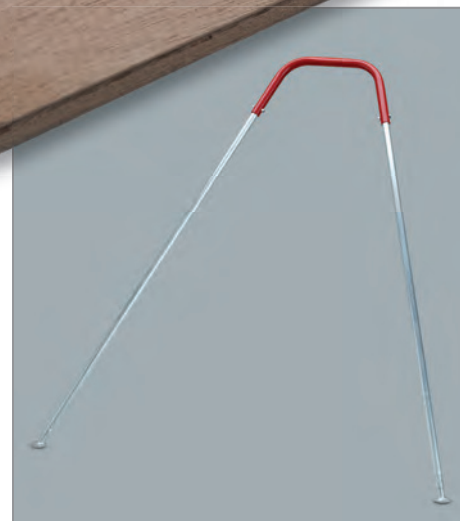

## Pull Handle

Aluminium pull handle compatible with all tennis court brooms, broom-mats and wooden drag nets.

**No. 40861**



# Court Treatment Devices



## Universal Steel Wire Broom slim

For scratching the court surface and removing leaves from court. Ideal device for spring, season and autumn. Light design with aluminium rail and drag cord.

200 cm width

No. 40925

## Replacement Broom 200 cm

No. 40926



## Universal Steel Wire Broom

Roughening of hard and water-impermeable courts. For removing surfaces overgrown with moss. Ideal equipment for the work in spring. Should not be missing on each tennis court. Heavy model including aluminium pulling handle.

No. 40920

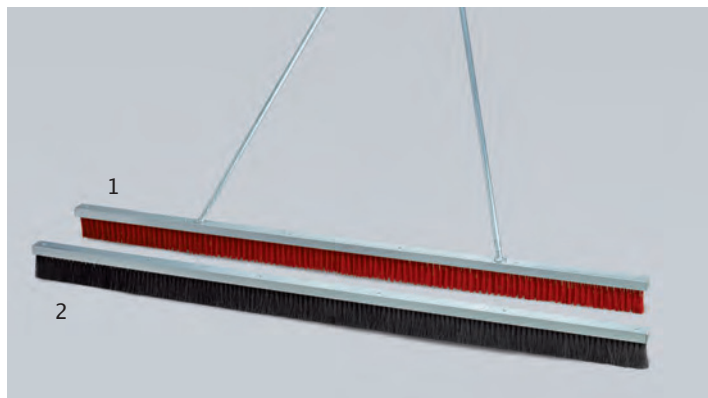

## Tennis Court Broom

With long, narrow bristles. Wide aluminium bracket and frame, 200 cm width.

No. 40942 Arenga 2)

No. 40943 Plastic 1)

## Replacement Brush 200 cm

No. 409420 Arenga 2)

No. 409430 Plastic 1)



## Tennis Court Broom I

With long, narrow bristles. Easy handling due to the adjustable pulling handle.

Aluminium frame, 270 cm width.

No. 40940 Piassava 2)

No. 40950 Plastic 1)

## Replacement Brush 135 cm

No. 40960 Piassava 2)

No. 40970 Plastic 1)

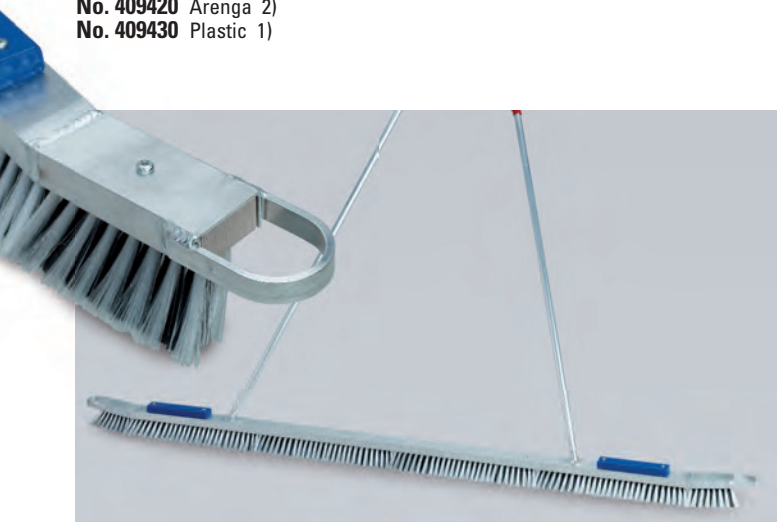

## Granu-Top

This is the perfect broom for cleaning granular surfaces. The bent ends of the broom and the position of the bristles guarantee an even spread of granules. The static supercharge cleans debris abraded from the balls and lint from the surface. Complete with aluminium handle and weights on both ends. Working width 200 cm.

No. 41076

## Replacement Brush for Granu-Top

No. 410761



## Broom for Granular Surfaces

Broom with Arenga bristles for hall floors with rubber granular. The special position of the bristles guarantees an even sliding of the broom. Complete with a very sturdy aluminium handle in three parts. Working width 200 cm

No. 41075

# Court Treatment Devices

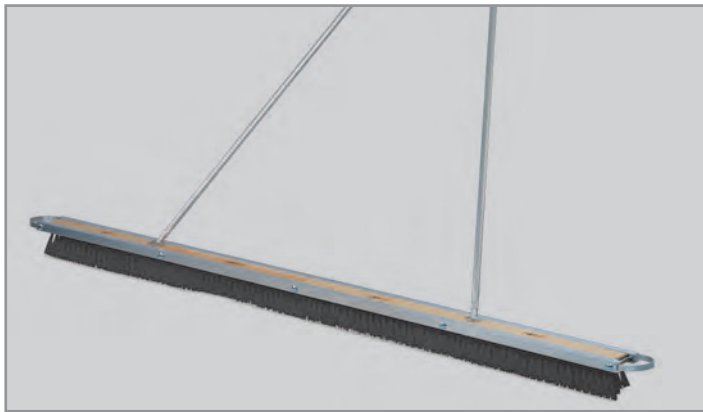

## Universal Tennis Court Broom Arenga black

With four replaceable broom parts in aluminium frame, complete with aluminium pulling handle, 200 cm width.

**No. 40870**

### Replacement Brush Arenga, black

**No. 40900** 50 cm

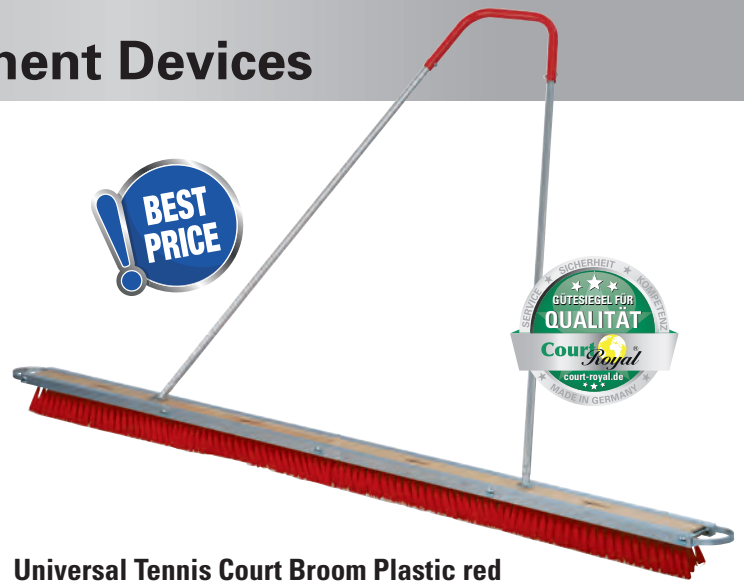

## Universal Tennis Court Broom Plastic red

The 200 cm width smoothing broom with 4 replaceable broom parts is the ideal maintenance device for clay courts. The aluminium base frame has net guards on each side. Complete with a two-part, sturdy aluminium pulling handle.

**No. 40860**

### Replacement Brush Plastic, red

**No. 40890** 50 cm

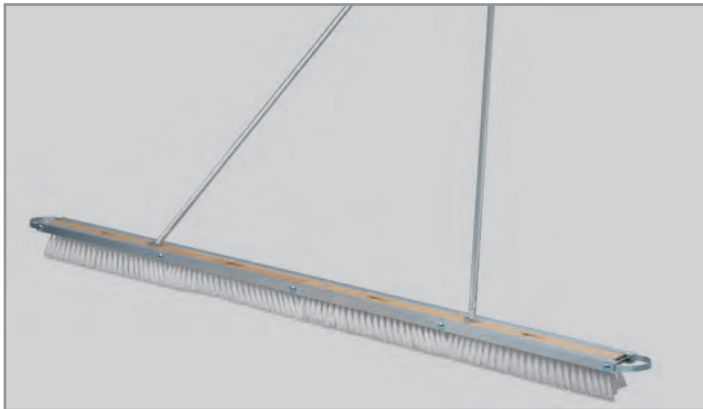

## Universal Tennis Court Broom Plastic white

Smoothing broom with 4 replaceable broom parts is the ideal maintenance device for clay courts. The aluminium base frame has net guards on each side. Complete with a two-part, sturdy aluminium pulling handle, width 200 cm.

**No. 40865**

### Replacement Brush Plastic, white

**No. 40864** 50 cm

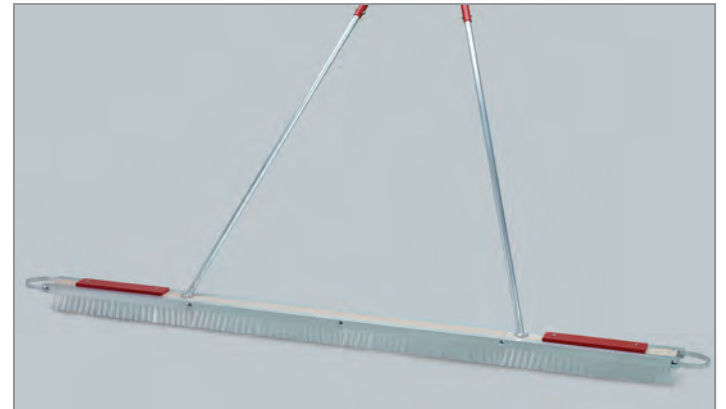

## Tennis Court Broom Special

Four replaceable plastic broom parts in aluminium frame, two additional weights to stop the broom from hopping or jumping, 200 cm width. Complete with aluminium pulling handle.

**No. 40862**

### Replacement Brush Special

**No. 40864** 50 cm

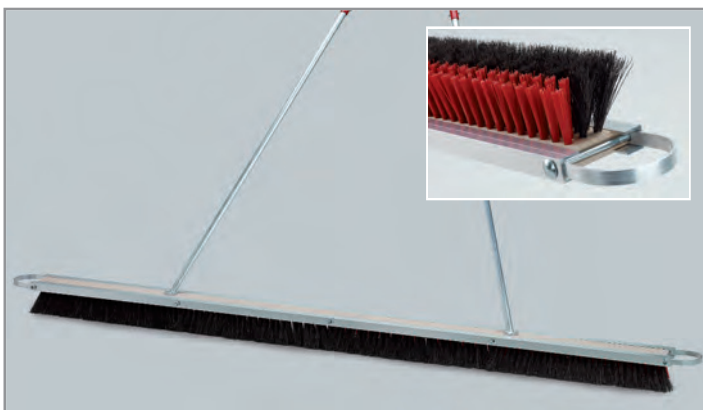

## All-Weather Smoothing Broom

The newly developed 200 cm width smoothing broom with 4 replaceable broom parts is the ideal maintenance device for clay courts. The brush section consists of two rows of plastic bristles and three rows of Arenga bristles. The plastic bristles at the front loosen the material, the Arenga bristles at the rear distribute the loosened material evenly over the court. The aluminium base frame has net guards on each side. Complete with a two-part, sturdy aluminium pulling handle.

**No. 40935**

### Replacement Brush

**No. 40936** Plastic / Arenga 50 cm:

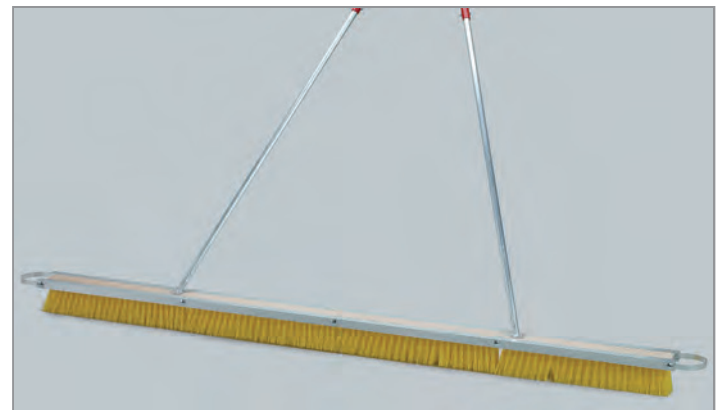

## Tennis Court Broom for Quartz Sand Plastic yellow

The Smoothing Broom with 4 replaceable broom parts is the ideal maintenance device for quartz sand courts. The aluminium base frame has net guards on each side. Complete with a two-part, sturdy aluminium pulling handle, width 200 cm. and yellow plastic bristles

**No. 40881**

### Replacement Brush Plastic, yellow

**No. 40883** 50 cm



# Court Treatment Devices



## Line Brush Top

Sturdy plastic-coated aluminium handle with joint. Brush with high-quality bristles.

**No. 41134** Arenga (soft)

**No. 41137** Plastic (hard)

## Replacement Brush Top

**No. 41135** Arenga (soft)

**No. 41138** Plastic (hard)

## Solid Plastic Line Brush

Molded plastic body with wear-resistant bristles. The ideal, long-lasting line brush. Supplied with a robust aluminium handle.

**No. 41112**

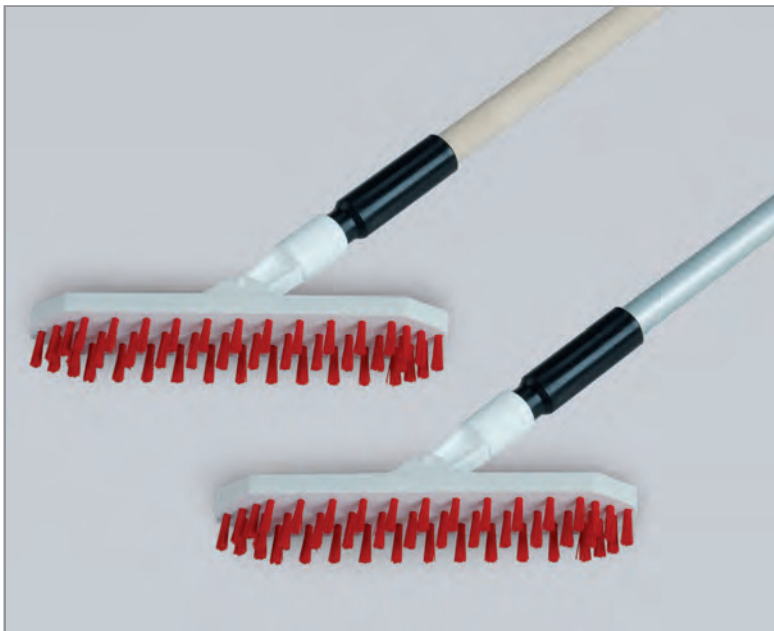

## Line Brush Nuovo

Plastic line brush with articulated joint, easy to use.

**No. 41125** with wooden handle

**No. 41124** with aluminium handle

## Replacement Brush Nuovo

**No. 41126**

## Replacement Wooden Handle for NUOVO

**No. 41127**

## Replacement Aluminium Handle for NUOVO

**No. 411261**



## Line Brush I with handle

**No. 41116** Plastic

**No. 41117** Arenga

## Line Brush II without handle

**No. 41100** Plastic

**No. 41110** Arenga

## Wooden Handle Ø 24 mm

**No. 40091**



# Court Treatment Devices

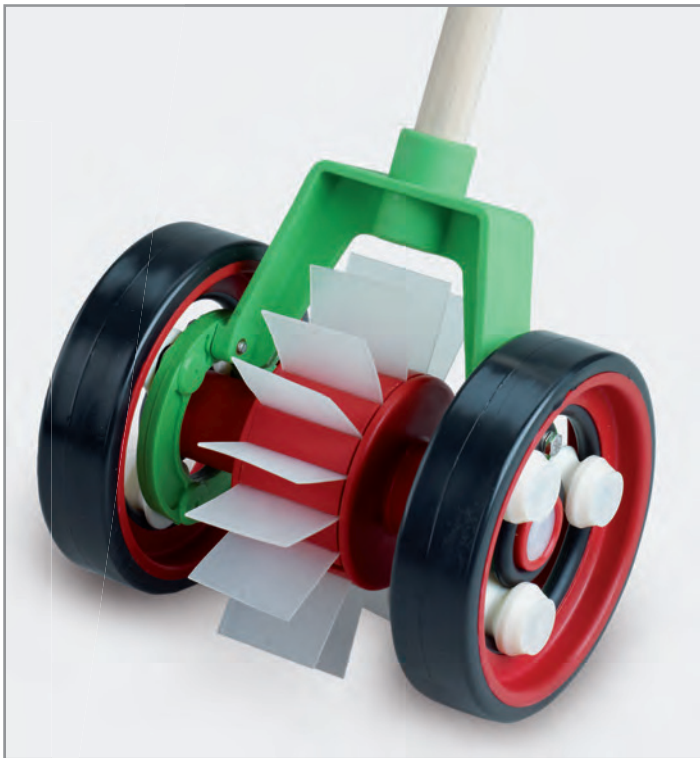

## Line Master

This new line cleaning machine is the best-seller in the USA. The friction-wheel drive, powered by the solid rubber wheels, pins the plastic brush to clean lines quickly and easily. Robust aluminium case with ergonomically shaped handle.

No. 41087



## Line Lightning Sweeper

Perfected, well-designed line cleaner for all surfaces, especially clay, shale and rubber granule surfaces. All parts replaceable. Without handle.

No. 41081

## Replacement Sweeper Blades

No. 41084

## Replacement Rolls

No. 41085

## Replacement O-ring set of four

No. 41086

## Bracket

No. 41088

## Replacement Wheels set of two

No. 41089



## Match Liner

Counter running brush sweeper for all tennis surfaces. Hard-wearing weather-proof construction. Without handle.

No. 41082

## Replacement Brush

No. 41083

## Handle 24 mm

No. 40091





# Court Treatment Devices

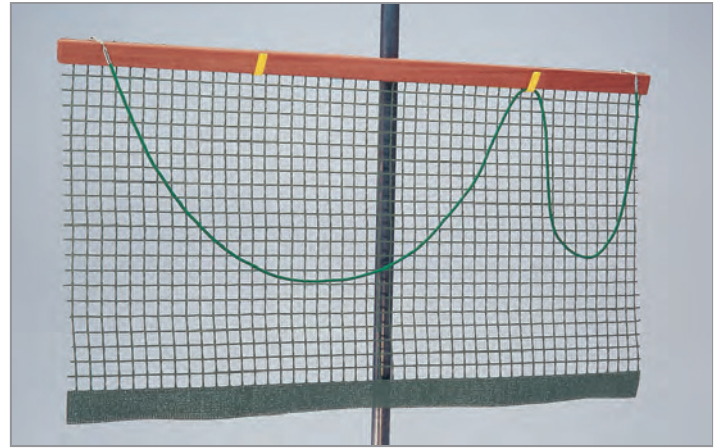
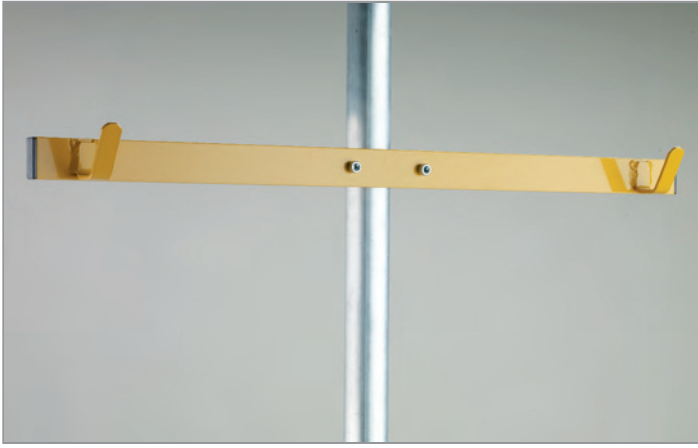

## Drag Net Double Holder

The newly developed double drag net holder for ideal storage of smoothing and drag nets. Made of aluminium tubing with two hooks and a fixing bracket for fence posts with  $\varnothing$  60 mm. The holder is coated in yellow plastic and therefore easily visible.

**No. 41434**



## Tool Holder

Zinc-plated steel, fixing bracket with standard hook. To hang brooms, drag nets and smoothing mats.

**No. 41430**  $\varnothing$  45 mm

**No. 41440**  $\varnothing$  60 mm



## Drag Net Holder

Made of galvanized flat iron, 3 mm thick, includes fixing materials for trouble-free assembly on fence post.

**No. 41443**



## Handle Holder

For line brushes and all other equipment with a broom handle diameter of 23–28 mm. The rubber holder holds the handle securely. The holder can be easily attached to a fence post with  $\varnothing$  60 mm, by using clamps.

**No. 414321**



## Tool Holder EXTRA

Fixing clamp with rubber lining. Does not damage posts. All steel parts zinc-coated. For brooms, drag nets and smoothing mats. For fence post with 60 mm  $\varnothing$ .

**No. 41435**



## Tool Holder

Fixing clamp with 1 hook. For brooms, drag nets and smoothing mats. Made of zinc-coated steel, for fence post with 60 mm  $\varnothing$ .

**No. 41431**



## Hand Brush Holder

Fixing bracket with 2 hooks for hanging hand brushes. Made of steel, for fence post with 60 mm  $\varnothing$ .

**No. 41433**

# Court Treatment Devices



## Tennis Court Drying Set

Bucket with galvanized grid plate and sponge with aluminium handle. To soak up small puddles on the court.  
**No. 41182**



## Tennis Court Drying Sponge

To soak up smaller puddles on the court.  
 Dimensions: 50 x 80 x 8 cm  
**No. 41155**



## Water Roller

Foam rubber roller with handle. To clear puddles from hard courts, 90 cm wide. All metal parts galvanized.  
**No. 41180**

## Spare Roller for Water Roller

**No. 41181**

## Universal Absorbing Roller Special

Absorbing drum with foam rubber covering, hot-galvanized frame and drum body. Thanks to the huge absorbent capacity of this roller it is possible to make a court playable again in a very short period of time.  
 Working width 80 cm.  
**No. 41141**

## Replacement Absorbing Drum

**No. 41150**

## Replacement Sponge with adhesive

**No. 41151**



## Rubber Squeegee "Dry Court"

Made of aluminium, 145 cm wide, replaceable rubber blade, 2 durable wheels in front. Easy and convenient for water removal and ball collection. Works especially well around pools, on driveways, golf greens and any flat or hard surfaces.  
 Comes with one blade for replacement.  
**No. 41183**

## Replacement Rubber Blade

**No. 41184**



# Sprinkler



## Full-circle Sprinkler

Large surface sprinkler with a circle diameter of 32 m, thus sprinkling a total area of 800 sqm. Connection 3/4". Without tripod.

**No. 41322**



## Part-Circle and Full-Circle Sprinkler

Large surface sprinkler with a circle diameter of 32 m, thus sprinkling a total area of 800 sqm. Working area can be adjusted from 20° to 340°, or full-circle. Connection 3/4". Without tripod.

**No. 41321**



## Turbo Quadrilateral Sprinkler

For medium-sized and large areas. Sprinkles an area of 400 sqm with a fine spray nozzle. Without tripod.

**No. 41330**



## Circular Sprinkler

Large-area sprinkler with a circle diameter of 32 m, thus sprinkling a total area of 800 sqm. Without tripod.

**No. 41320**

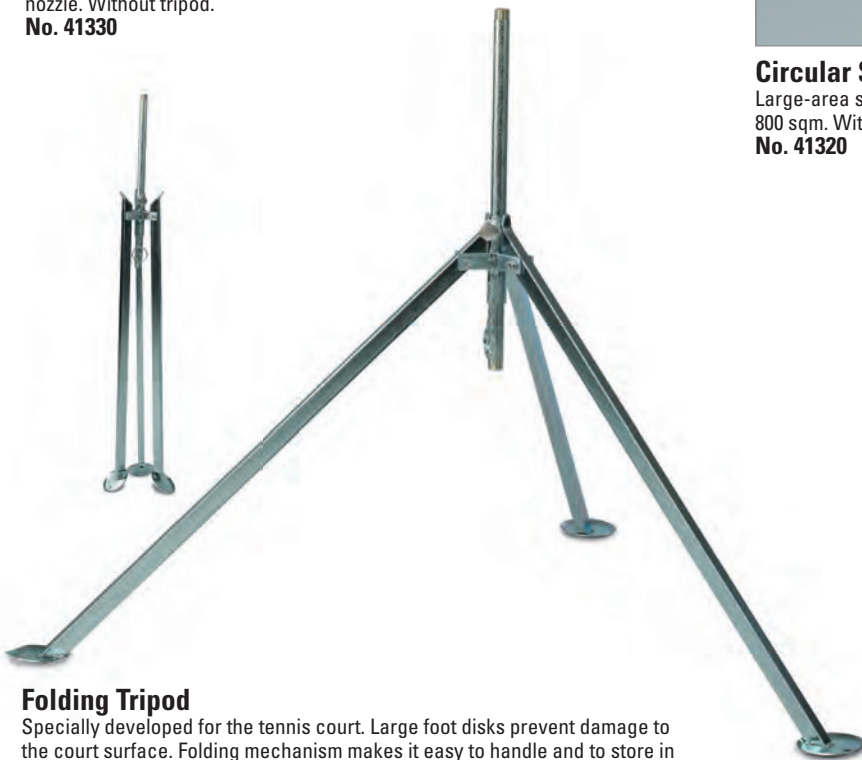

## Folding Tripod

Specially developed for the tennis court. Large foot disks prevent damage to the court surface. Folding mechanism makes it easy to handle and to store in small places. Suitable for all types of sprinklers in our catalog.

**No. 41323**



## Perrot In-Ground Sprinkler

LVZA 22 – 2 WT 4.0 mm

Single nozzle, pop-up sprinkler with galvanized steel housing; durable plastic cover, elbow and guide housing. Trajectory 22° and anti-back-splash impact lever and diffuser pin.

**No. 41331**

# Sprinkler



## Spray Nozzle

Large nozzle sprinkles evenly over large areas. Complete with Geka connection and tube.

**No. 41340**



## Spray Nozzle with Shut-Off Valve

Large nozzle sprinkles evenly over large areas. Complete with Geka connection and tube. With shut-off valve.

**No. 41350**



## Pistol Spray Nozzle

Large nozzle sprinkles evenly over large areas. With a pistol grip. Optimum adjustment of sprinkling with shut-off device.

**No. 41360**

## Adjustable Nozzle

Made of light alloy metal with hard PVC steel tube. Metal ball valve lever and spray adjuster. Jet length approx. 15 m. Complete with Geka connection.

**No. 41361**



## Water Hose Special

Quality hose, especially for tennis courts, resistant to low temperatures. Flexible, compression-proof, weatherproof. Available in 50 m lengths.

**No. 41371** 3/4"

**No. 41381** 1"

## Water Hose

Especially for tennis courts and sports grounds, green. Available in 50 m lengths.

**No. 41370** 3/4"

**No. 41380** 1"



41403

41391

41402

## Geka adapters, brass

**No. 41391** 3/4"

**No. 41401** 1"

## Gaskets for Geka

set of 10 pieces

**No. 41342**

## Connectors, brass with Geka

**No. 41402** 3/4"

**No. 41404** 1"

## Gaskets for internal thread

set of 10 pieces

**No. 41405** 3/4"

**No. 41406** 1"

## Hose clip, set of 10 pieces

For water hose up to 2"

**No. 41403**

## Gaskets for spray nozzle

set of 5 pieces

**No. 41341**



# Shoe Cleaner - Waste Bins - Signs

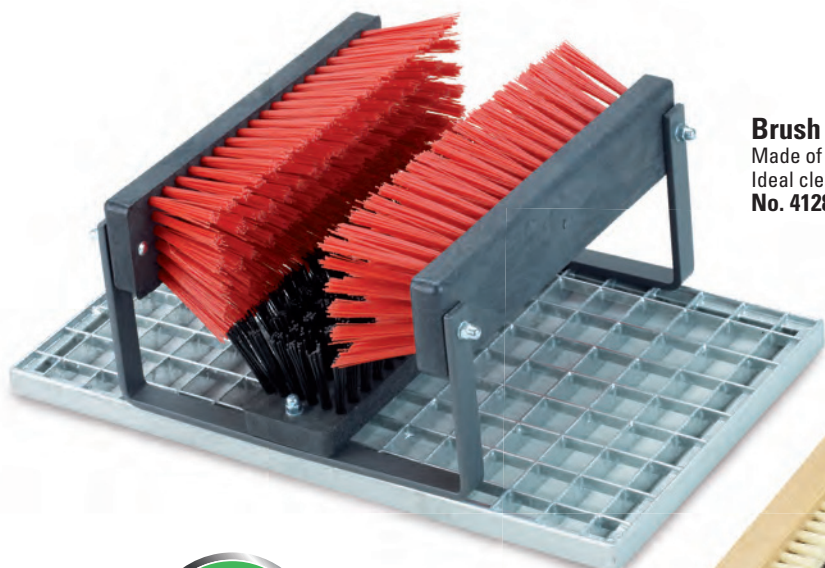

## Brush Shoe Cleaner Ideal

Made of zinc-coated steel with high-quality bristles. Ideal cleaner for sand and clay courts. 600 x 400 mm.  
**No. 41284**



## Tennis Shoe Cleaner wood

Made from polished beech wood. Size 360 x 270 mm. Extremely durable non-slip construction.  
**No. 41269**



## Tennis Shoe Cleaner Little

Solid plastic construction. Size 270 x 350 mm  
**No. 41271**

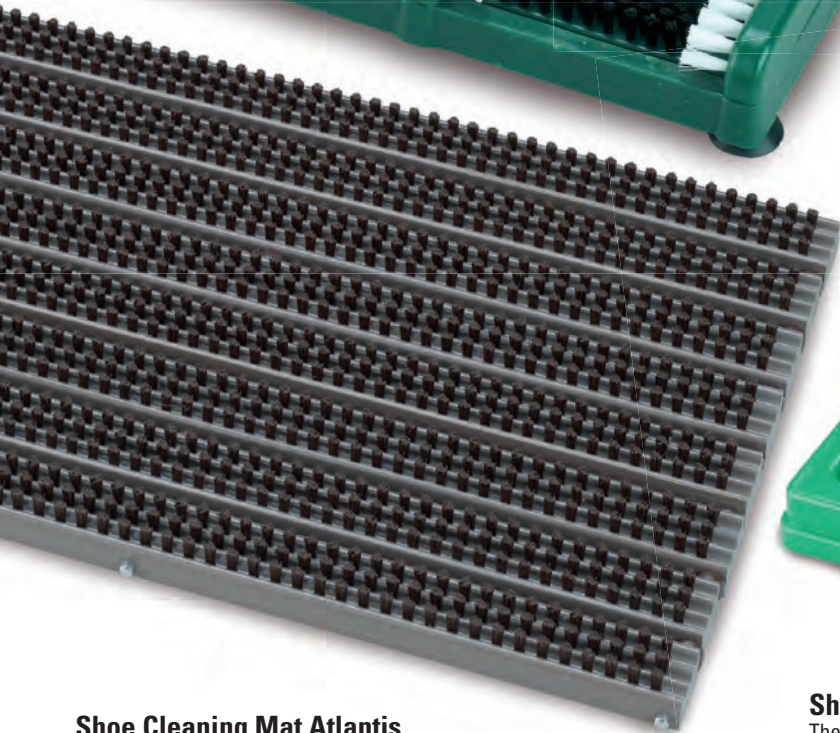

## Shoe Cleaning Mat Atlantis

A solid, stiff brush mat made of recyclable synthetic material.

Width: 590 x 380 x 30 mm.

**No. 41280**



## Shoe Cleaning Tub

The perfect cleaner for all kind of sports shoes. Fine sprays of water in the punched rubber mats clean the soles of the shoes when triggered by the person's weight. Can be used for clay, granule and sand courts. Dirt remains in the tub.

Easy to clean. Size 600 x 500 mm.

**No. 41286**



# Shoe Cleaner - Waste Bins - Signs



## Designer Waste Bin

In the shape of a tennis ball, approx. 50 cm Ø. Made from top-quality special plastic. Completely UV and weather-resistant. Hinges and fastening materials made from stainless steel. Hinged lid. Standard version with 2 quick-release straps for mounting on poles, railings or walls.

**No. 41223** green



**No. 41224** yellow



## Waste Bin 50 I

UV-resistant plastic waste bin. Heavy-duty hot galvanized metal fixture for fastening to poles, railings or walls. Complete with hardware and key.

**No. 41233** green

**No. 41234** orange



## Waste Bin Court Royal

Practical PVC waste bin with storage tray. The waste bin (36 x 23 x 42 cm) is easy to hang under the tray.

The tray has got recesses for balls, cups and a storage area. Size: 40 x 20 cm.

Mounting for round max. 90 Ø mm and angular max. 90 x 90 cm posts for use on tennis posts, fence posts and Umpire's Chair.

**No. 41232** green



## Wire Waste Bin 75 l

2 mm strong hot-galvanized frame with 4.8 mm round steel legs. Metal base with holes for water drainage.

Size: 40 cm Ø; height 60cm

**No. 41278**

## Wire Waste Bin 18 l

Semi-circular, galvanized with perforated metal base to drain water. Spring hooks for fastening to fence.

Size: height 14 cm, width 32 cm, depth 17 cm.

**No. 41236**

## Wire Waste Bin 63 l

2 mm sturdy, strong hot-galvanized frame. 4.8 mm round steel legs. Size: 40 cm Ø; height 50 cm.

**No. 41277**

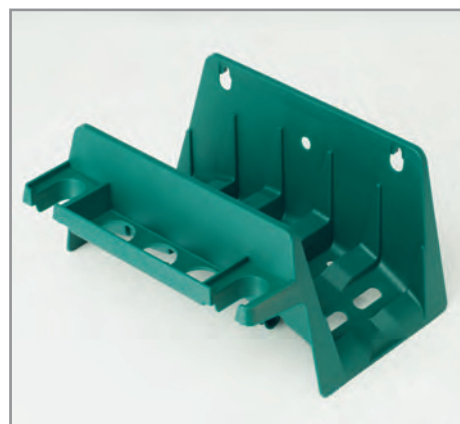

## Hose Holder

For wall mounting. Sturdy construction, for inside and outside use, polypropylene material, perfect hose storage.

**No. 41382** green



# Shoe Cleaner - Waste Bins - Signs



**Match Timer**

The new tennis court booking clock with integrated court number, made of weatherproof plastic. Can be set to 1 hour for singles or 1 1/2 hours for doubles. Size 24 x 32 cm. No. 1-12 available. No. 41249



**Tennis Court Numbers**

White plastic board with black numbers from 1 - 9, size 300 x 200 mm. No. 41250  
Numbers from 10 - 20, size 300 x 400 mm. No. 41260



**Sign for Court Rules**

White plastic board with sweeping illustration. No tennis court should be without this sign. Size 500 x 330 mm. No. 41241 German  
No. 412401 English  
No. 412402 French



**Sweeping Illustration Sign**

Size 330 x 500 mm, white plastic board. No. 41242



**Court closed sign**

Size 300 x 200 mm, white plastic board. No. 412431



**All Courts Closed Sign**

Size 300 x 200 mm, white plastic board. No. 412461



**Shoe Sign**

Size 300 x 300 mm, white plastic board. No. 4128301



**Tennis Hall Shoes Sign**

Size 300 x 200 mm, white plastic board. No. 412461

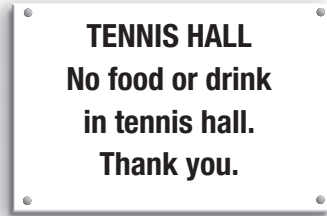

**No Food and Drink Sign**

Size 300 x 200 mm, white plastic board. No. 412451



**No dogs allowed sign**

Size 300 x 300 mm, white plastic board. No. 412441



**Dogs on leash sign**

Size 300 x 200 mm, white plastic board. No. 412481

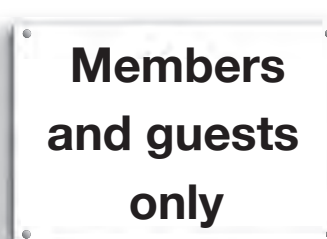

**Members and guests sign**

Size 300 x 200 mm, white plastic board. No. 412471

# Ball Machines - Training Walls



## Tennis Tutor ProLite

The wide speed range makes this machine a superb choice for all beginners. Due to the small size and light weight it can be stored easily and fits in almost all car trunks. A good choice for sports lessons in schools as well as for private use. The ball feed rate is electronically variable from one ball every 1.5 seconds to one ball every 10 seconds. The ball trajectory is manually adjustable from groundstroke to towering lob. The oscillator delivers shots randomly across the court.

### Technical details:

Ball capacity:	125 balls
Dimensions (HxWxD):	closed 31 x 50 x 46 cm
Weight:	13 kg
Power:	battery
Playing time:	2 - 3 hours
Recharging time:	12 hours
Feeding interval:	1.5-10 sec.
Top speed:	96 km/h
Ball flight:	stop to lob
Line-directions:	1 direction and random
Ball spin:	no
Case:	plastic
Remote control:	no – on-off switch

**No. 42013**



## Tennis Tutor

A battery powered beginner model which can be stored easily. Tennis Tutor is portable and towable like luggage if the towing handle is extended. Ball speed ranges from a gentle toss for children to high-speed for advanced learners. Ball trajectory can be set anywhere between groundstroke and lob. The machine can be set to repeat shots, to oscillate and random shots across the court.

### Technical details:

Ball capacity:	150 balls
Dimensions (HxWxD):	31 x 50 x 50 cm
Weight:	19 kg
Power:	battery
Playing time:	2-3 hours
Recharging time:	2 hours
Feeding interval:	1-12 sec.
Top speed:	136 km/h
Ball flight:	stop to lob
Line-directions:	1 direction and random
Ball spin:	no
Case:	plastic
Remote control:	yes on/off

**No. 42012**



## Tennis Twist

Especially designed for children and beginners. The Tennis Twist can be used in clubs and schools as well as in backyards, driveways and even basements. The machine is very easy to use - just turn it on and it shoots a ball every five seconds. The arc of the ball can be adjusted anywhere from approx. 3 - 6 meters.

### Technical details:

Ball capacity:	28 balls
Dimensions (HxWxD):	50 x 20 x 20 cm
Weight:	5 kg
Power:	battery
Playing time:	5-6 hours
Feeding interval:	5 sec.
Top speed:	15 km/h
Ball flight:	straight
Lines-directions:	1 direction
Ball spin:	no
Case:	plastic
Remote control:	no – on-off switch

**No. 42016**



# Ball Machines - Training Walls



## Ball Machine Playmate Portable

High-quality machine with aluminium cabinet. Very easy handling and compact storage. Holds 200 balls, battery powered with on/off remote control. Variable back and top spin, oscillation with one, two or three lines.

### Technical data:

- Ball capacity: 200 balls
- Dimensions(HxWxD): 64x56x48 cm
- Weight: 31 kg
- Power: battery
- Playing time: 6 hours
- Recharging time: 12 hours
- Feeding interval: 1-10 sec.
- Top speed: 140 km/h
- Ball flight: short-long
- Line-directions: 2 direction and random
- Ball spin: topspin and slice
- Case: Aluminium
- Remote control: yes on-off

**No. 42003**

## Playmate ACE

One of the top-selling machines in the USA. Comes with an ON/OFF remote control. Ball frequency: Two different ball speeds and spins. Elevation control; ball can be played from a drop shot to a baseline drive; variable topspin and backspin. Oscillation to one, two or three lines.

### Technical data

- Ball capacity: 200 balls
- Dimensions(HxWxD): 96x48x87 cm
- Weight: 33 kg
- Power: 220 volts
- Feeding interval: 1-10 sec.
- Top speed: 150 km/h
- Ball flight: short-long adjustable
- Line-directions: 3 directions right-left-right
- Ball spin: topspin and slice
- Case: Aluminium
- Remote control: yes on-off

**No. 42034**



## Universal Tennisball-Collector

This new ball collector collects all spread out balls in shortest time. Basket can be removed easily and emptied into the ball trolley or ball machine. The tentacles are retractable. High quality aluminium construction with big wheels. Basket can be hooked to the handle when balls are played.

**No. 42076**



# Ball Machines - Training Walls

## Ball Machine Playmate i-Smash

The best of the ball machines. Can be set in seven directions. For example: right, center, left, left right, right, center. It plays topspin, slice and short-long. The ball sequence can be continuously adjusted to 6-60 balls per minute. An ideal device for individual or group training. Throws accurately and is low noise.

### Technical data:

- Ball capacity: 300 balls
- Dimensions(HxWxD): 96 x 54 x 92 cm
- Weight: 35 kg
- Power: 220 volts
- Feeding interval: 1-10 sec.
- Top speed: 150 km/h
- Ball flight: short-long adjustable
- Line-directions: 7 directions right-left-right
- Ball spin: topspin-slice
- Case: Aluminium
- Remote control: yes on-off

No. 42032



## i-Playmate for i-Phone & i-Pad

The innovation for tennis training on new level. With this additional module it is possible to steer the ball machine completely with your i-phone or i-pad and simultaneously you are able to record your training successes and compare them.

No. 42006

## Remote Control Playmate

General remote control for all Playmate ball machines.

No. 420342



## Charger

For Playmate Transportable  
No. 420033



## Power Pack

For Playmate Transportable  
No. 420032

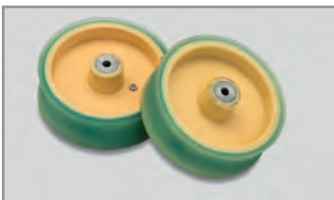

## Ejection Wheels

For Playmate Transportable  
Diameter: 15,3 cm  
No. 420031



## Ejection Wheels

For Playmate ACE and i-Smash  
Diameter: 20 cm  
No. 420341



## Covering Hood

For all Playmate Ball Machines  
No. 42004 for Playmate Transportable  
No. 42007 for Playmate ACE  
No. 42031 for Playmate-i-Smash



# Ball Machines - Training Walls



## Smash-Back Training Wall

Made of acrylic and frostproof concrete. Homogeneously sealed green coating offers additional protection. Parabolic playing surface guarantees a spot-on ball rebound. The white marking lines are indestructible. This training wall is simply mounted and bolted to a strip foundation with recessed anchor bolts. Can be supplied in two heights, 230 and 300 cm with a 100 cm protective screen. Width individually adjustable with elements. Integration of sound-proofing, recommended in residential areas.

### Typ II E

Playable on one side. Height 230 cm, element width 148 cm, without protective screen.

**No. 42060**

### Typ II D

Playable on both sides. Height 230 cm, element width 148 cm, without protective screen.

**No. 42061**

### Typ I E

Playable on one side. Height 300 cm, element width 100 cm, without protective screen.

**No. 42062**

### Typ I D

Playable on both sides. Height 300 cm, element width 100 cm, without protective screen.

**No. 42063**

### Protective screen Typ E

For single-sided playing walls. Hot galvanized, angled ball protective screen. 100 cm high.

**No. 42064**

### Protective screen Typ D

For double-sided playing walls. Hot galvanized, angled ball protective screen. 100 cm high.

**No. 42065**

### Noise Reduction Type I an II E

For single-sided playing walls, 2,30 and 3,00 m. Prefabricated acrylic concrete slabs with covering and insulating materials.

**No. 42066**

### Side panelling

for Smash-Back rebound wall

**No. 42068**





# Ball Machines - Training Walls



## Air-Tennis practice wall

The recently developed Air-Tennis tennis practice wall is the ideal training partner for everyone, from beginners to experts. This product is a unique and absolutely unbeatable piece of training equipment for use in stationary or transportable mode. It comes in a bag and is easy to transport. To set it up, simply unfold it on the ground and roll it out. Use the bellows (supplied), then fill it with air - it just takes seconds. You can use the air pressure gage, also supplied, to check that the air pressure is at the right level, as this also affects the way the ball bounces back. There are also attachment straps on both sides for attaching the practice wall to our pairs of stands, fences, or sports hall walls. The ground protection sheet, also supplied, is simply attached to the rear side of the wall with hook and loop fastener. You can also empty it in seconds, simply by turning over the bellows. Players can play on both sides of the Air-Tennis practice wall. It has lines marked on it at the height of the net to guide the player. Tested by international trainers who rated it very highly.

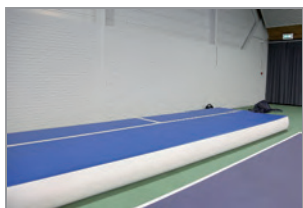
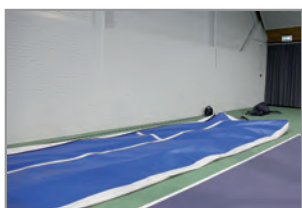

### Air-Tennis practice wall 3 m

300 x 180 cm  
No. 42020

### Air-Tennis practice wall 4 m

400 x 180 cm  
No. 42021

### Air-Tennis practice wall 5 m

500 x 180 cm  
No. 42022

### Air-Tennis practice wall 6 m

600 x 180 cm  
No. 42023

### Air Tennis practice wall set

300 x 180 cm complete with stands.  
No. 42025



You can download the informative film about using and instructions here.



Use



Setup



Pair of stands  
No. 42024





# Ball Machines - Training Walls



## Roobak Training Net Wall

Made of powder-coated steel tubes. Roobak is a product developed in Australia. With the adjustable net tension and various setting angles it is possible to simulate serves and returns up to 10 meters.

The extreme rebound speed enables a normal playing rhythm and ball control for both beginners and professionals. Different games are possible with the eight marking cones. Dimensions: 150 x 150 cm, weight 6 kg.

**No. 45010** hot pink

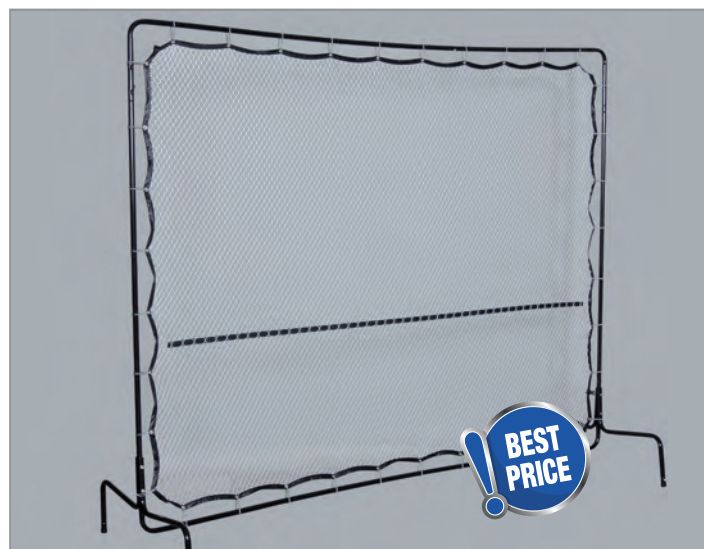

## Tennis Net Training Wall

Transportable net wall of enameled tubular steel. Infinitely adjustable, for different ball variations. Size: 2.80 x 2.20 m.

**No. 42040**

**Replacement net** for Tennis Net Training Wall 2.60 x 2.0 m.

**No. 42041**

**Replacement springs**

**No. 42037**



## Multi Sports Radar

This new speed control measuring instrument can be used for tennis, golf, football and many other ball games. The ball speed can be displayed within a few seconds.

### Technical Data:

- Speed control from 5 to 199 km/h or 3 to 150 m/h
- Measuring distance from 1-12 m
- Three-figure LED-display with 55mm high digits
- Voice-announcement of the displayed digits is adjustable
- On the average batteries without voice are non-perishable ca. 50h, batteries with voice ca. 30h.
- Automatic switch-off- function for saving the batteries
- 5 AA batteries are needed (Not contained in consignment).
- Suitable for all tripods
- Dimensions: 18 cm x 15 cm x 12 cm

**No. 43003**

## Tripod for Multi Sports Radar

**No. 43002**



# Ball Baskets - Balls



## Ball Catcher

The new ballnet eliminates the risk of an injury because of tennis balls lying around the court. Whether by child-, group-, or individual training, or by use of a ball machine, this net prevents balls from rolling onto the court. Quick and easy pick-up saves additional time.

**No. 40569**

### Short operating instructions

- roll apart the net
  - connect the eyelets with the provided rubber bands
  - pull the net over the posts with help of another person
  - the lower rubber band has to be fixed down at the ground, the upper one about 16 inches above
  - finally attach the bar spacer through the net on the same level
- Now you are ready to go.**

Use this QR-code for downloading the instruction movie

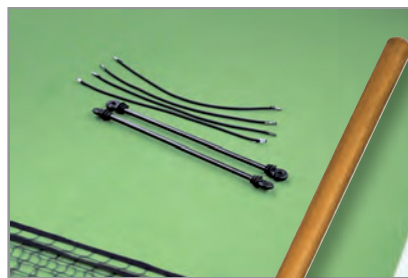
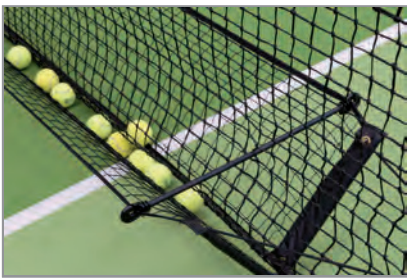

## Tennis Ball Wizard

Balls are removed from the practice area in lightning speed. The quickest tennis ball collector on the market. First of its kind in the world. It makes collecting balls fun. Simply "roll" the balls into the collector and empty them into the pail and then the fun can begin again. Capacity 25 balls. Delivery content: collector with handle, pail and prong to open collector for emptying.

**No. 42089**



# Ball Baskets - Balls

## CLAX ® Ball Trolley

This newly developed trolley is essential for all tennis trainers. Due to the use of aluminium and a high-grade plastic, a high durability is guaranteed. The easily smooth-running wheels are bearing mounted and are equipped with lever brakes. Foldable within seconds. Storable in almost all trunks. A 46 l folding box is included but any other 32 or 46 l boxes can also be used. The boxes can be transported on the upper as well as on the lower platform. Load capacity of upper level 20 kg and the lower platform 40 kg.

Dimensions:

Completely opened: (L x W x H) 55 x 103 x 89 cm, folded together: (L x W x H) 55 x 71 x 18

Cage Height: 85 cm, Cage size: (L x W x H) 60 x 34 x 26 cm0

Capacity: 120 balls, Weight: 10 kg

No. 26000

## Replacement box for CLAX trolley

No. 26001



## Ball Trolley Court Royal

Very stable and easily moveable trolley with large casters. Big ball basket and extra storage tray. Chrome-plated frame. The baskets and the lockable cover are powder-coated black. (lock not included)

Capacity: 330 balls, Size: (L x W x H) 60 x 49 x 92 cm

Cage Size: (L x W x H) 60 x 49 x 36 cm

Weight: 10 kg

No. 43021



## JOWO Tennis Caddy

The ideal partner for professional tennis trainers. Three height adjustment settings, simple and fast handling in transport. Can be folded for storage in a small space. Lockable cover. Sturdy, weatherproof structure.

Capacity: 220 balls.

No. 42087

# Ball Baskets - Balls



## Ball Basket Court Royal

The best-selling ball basket. Very sturdy, chrome-plated for collecting balls without bending over. Handle can also be used as stand. Locking cover, sturdy construction. Lock not included. Capacity: 70 balls.  
**No. 42080**



## Ball Pickup Tube Court Royal

Saves time and efforts picking up balls. Simply press this practical tube down onto the balls on the floor and it picks them up. Holds 17 balls. To empty the tube, just open the cover at the opposite end.  
Length 120 cm, Weight: 0.8 kg  
**No. 42053**



## Ball Basket Professional

Sturdy wire basket with special plastic coating. To collect balls and for use as stand. Super locking mechanism. Very stable. Wheels for easy transport. Hinged cover to lock the basket. Ideal for everyday use. Capacity: 90 balls.  
**No. 42081**



## Plastic Ball Basket

Sturdy plastic ball basket with long handles that can be slid into both sides for use as a stand and for carrying the basket. Standing height 80 cm, Capacity approx. 80 balls., Weight: 1.9 kg.  
**No. 42073**

## BALLBASKET

HOLDS 80 BALLS

Want a better serve?  
Ballport and practice is the answer.

BALLBASKET is made of tough, durable, recyclable polypropylene. Assembly is a snap. Sides snap together and screws are provided. Easy assembly instructions are in the box. No rust or weld breaks as with wire ball pickups. Handles flip over so you don't have to bend to pick up balls or bend down to take them out of the basket. So unique that multiple patents were granted.



Sliding Bars

Sliding bars at top provide quick closure for easy transport.



Steel handles lock in place automatically as you turn the handles up. Now you pick up balls without bending. Just place over balls and press down. Balls roll in.



Locks lock automatically when you flip them down.

When handles are tipped under they lock automatically.



Bottom Rolling Bars

Bars on the bottom turn as you pick up balls. This makes ball pick up even faster than forcing bars over balls (as with other ball pickups).



# Ball Baskets - Balls



**Tennisball Balls Unlimited Code black**  
A combination of natural rubber and woven English playnes felt. In our range of products this excellent tournament ball guarantees maximum performance and stability. Clearly less expensive than comparable brands. ITF approved tournament quality.  
**No. 46014** pack of 4



**Tennisball Balls Unlimited Code Red**  
A combination of natural rubber and woven TTI-felt. This tournament ball guarantees maximum performance and stability. A superb playing behavior and an excellent price/quality-ratio. ITF approved tournament quality.  
**No. 42093** pack of 4



**Tennisball TYGER X-Force**  
A combination of natural rubber and woven hightech felt. This top tournament ball guarantees maximum performance and is extremely durable. This excellent ball is ITF approved.  
**No. 46009** pack of 4



**Tennisball Balls Unlimited Code**  
High-quality woven TTI-felt from Thailand. Pressureless, durable tennisball for training use. Suited for ball machines.  
**No. 42092** pack of 60



**Tennisball Court Royal Coach**  
High-quality woven needle felt, perfect price/quality ratio, popular with trainers, excellent stability. Suited for ball machines.  
**No. 42091** pack of 60



**Universal Sport Coach**  
High-quality woven English TTI-felt. Pressureless tennisball in tournament quality. The long-lasting elasticity of the pressureless core guarantees extremely long stability. Especially suited for ball machines.  
**No. 42090** pack of 60



**BIMBI Easy Stage 2**  
High-quality woven flex felt. 40% slower and 20% lighter than normal tennisballs. Applied over years in smallfield-tennis-championships, ITF approved.  
**No. 46002** pack of 60

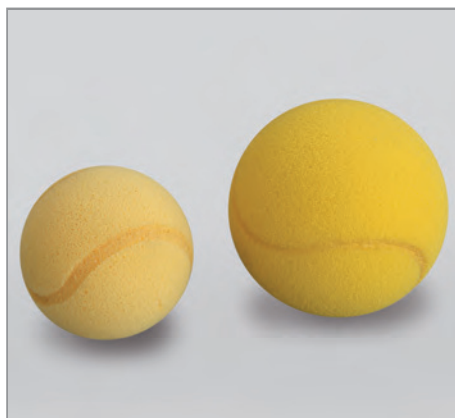

**Foam Balls**  
Polyurethane foam tennis balls, ideal for beginners. Slow play enables a good motion-sequence.  
**No. 20846** Ø 70 mm  
**No. 20844** Ø 90 mm



**Fun Ball**  
The fun ball bounces in all directions. Ideal for reaction-training. The harder balls are faster than the softer ones.  
**No. 42095** 7 cm soft  
**No. 420951** 7 cm hard  
**No. 420952** 10 cm soft  
**No. 420953** 10 cm hard

# Kid's Tennis



**Tennisball  
Balls Unlimited Stage 1,**  
High-quality woven flex felt. 25%  
slower and 10% lighter than normal  
tennisballs. ITF approved.  
**No. 45080** pack of 12



**Tennisball  
Balls Unlimited Stage 2**  
High-quality woven flex felt. 40%  
slower and 20% lighter than nor-  
mal tennisballs. ITF approved.  
**No. 45081** pack of 12



**Tennisball  
BIMBI Easy Stage 2**  
High-quality woven flex felt. 40%  
slower and 20% lighter than normal  
tennisballs. Applied over years in  
smallfield-tennis-championships,  
ITF approved. Weight: approx. 43g.  
An absolute premium product.  
**No. 460020** pack of 12



**Tennisball  
Balls Unlimited Stage 3**  
High-quality woven flex felt. 6%  
larger and 20% lighter than nor-  
mal tennisballs. ITF approved.  
**No. 45082** pack of 12



**Foam Ball Stage 3**  
Soft foam ball especially developed for starting off  
on the small field and midcourt. Distinctly larger than  
Stage 1 + 2 balls, slower bounce and flight behavior.  
**No. 42096** pack of 12



**Stage 1 Children's Racket**  
The perfect racket for children aged between 8 and  
12 years! For full court, length: 64 cm, weight: 220 g.  
**No. 45075**



**Stage 2 Children's Racket**  
The perfect racket for children aged between 7 and  
11 years! For mid court, length: 60 cm, weight: 200 g.  
**No. 45073**



**Stage 3 Children's Racket**  
The perfect racket for children aged between 5 and  
8 years. For mini court, length: 54 cm, weight: 180 g  
**No. 45072**



**Stage 4 Children's Racket**  
The perfect racket for children aged between 3 and 5  
years. For mini court, length: 48 cm, weight: 170 g.  
**No. 45071**



**Stage 5 Children's Racket**  
The perfect racket for children aged under 3. For mini  
court, length: 43 cm, weight: 150 g  
**No. 45074**



# Kid's Tennis

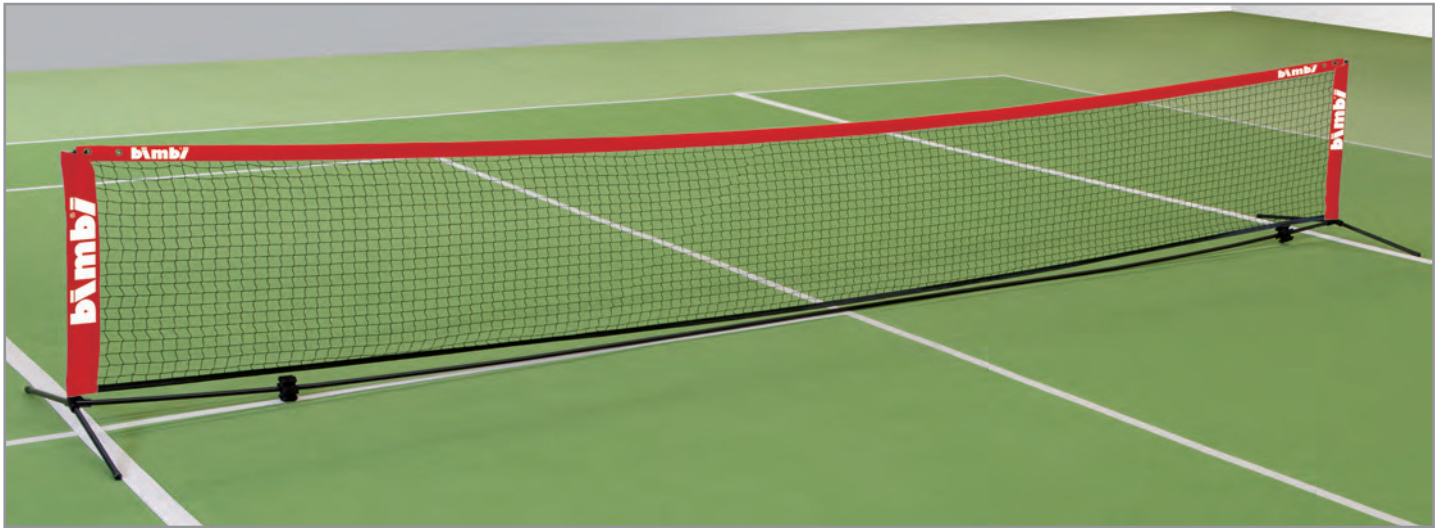

## Bimbi 6,10 m Small Court Tennis Net

Its practical connection system makes it quick and easy to assemble. Just slip the net over the two posts. 5 different net tension levels. Supplied with storage bag.

Size: 6.10 x 0.85 m

No. 40506

## Bimbi Replacementnet 6,10 m No. 40509

## Bimbi Replacementnet 3 m No. 40501

## Bimbi 3 m Small Court Tennis Net

Its practical connection system makes it quick and easy to assemble. Just slip the net over the two posts. 5 different net tension levels. Supplied with storage bag. Size: 3 x 0.85 m

No. 40500



## Bimbi Small Court Tennis Net, 3 m Street Set

Just like the Bimbi 3m Small Court Tennis Net, but with 2 Topspin 60 cm tennis rackets and 6 Bimbi Easy balls.

No. 40512



## Bimbi Small Court Tennis Net, 6.10 m School Set

Just like the Bimbi 6.10m Small Court Tennis Net but with 4 Topspin 60 cm tennis rackets and 12 Bimbi Easy balls.

No. 40510



# Kid's Tennis



## Bimbi Small Court Tennis System

This practical system was used in the small court tennis project run by the German Tennis Association and has proved its value. Fast and simple to assemble. Stable when assembled because of its wide stands. Ideal net tension with self-tensioning system. Can be stored in a small space in a practical bag. Official German Tennis Association size: 6.10 x 0.85 m. Weight approx. 6.5 kg. **No. 40488**

## Replacement net 610

**No. 40489**

## Bag

**No. 40503**

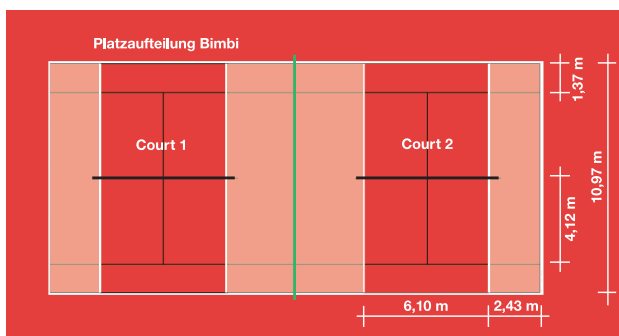

## Marking trolley for Tennis

New product developed for children's tennis, spreading width approx. 50 mm. **No. 45005**

## Chalk for Tennis Courts

5 kg. in pail **No. 45009**





# Kid's Tennis



## Bimbi Club Package II

Consists of: 1 Bimbi small court tennis system, 4 Bimbi children's rackets and 1 Bimbi Easy-Set.  
**No. 46033**



## Bimbi School Tennis Package II

Consists of: 2 Bimbi small court tennis systems, 16 Bimbi children's rackets and 2 Bimbi Easy-Sets.  
**No. 46031**

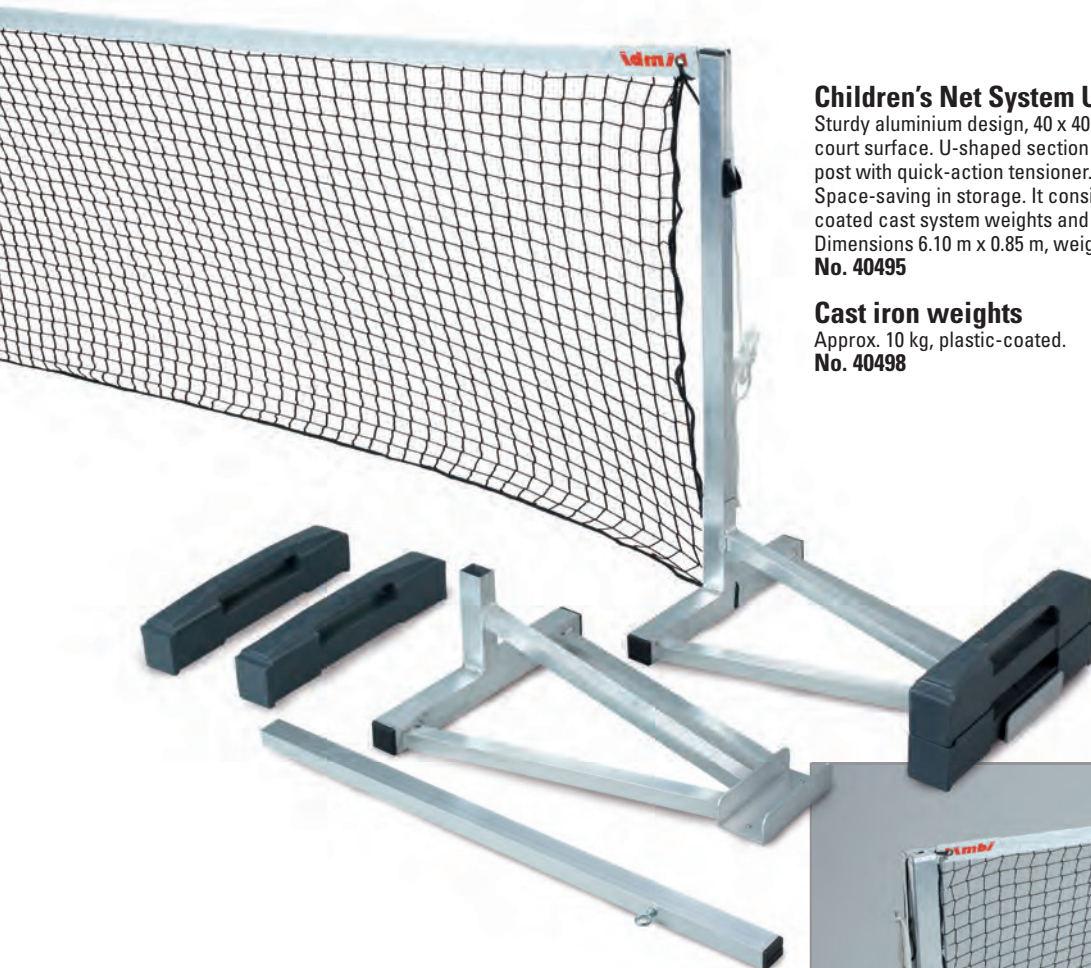

## Children's Net System USP I

Sturdy aluminium design, 40 x 40 mm tubular frame with rubber base to protect court surface. U-shaped section to insert the cast iron weights. Aluminium net post with quick-action tensioner. The system is easy to dismantle and to transport. Space-saving in storage. It consists of 2 aluminium bases, 2 net posts, 4 plastic-coated cast system weights and a nylon net.  
 Dimensions 6.10 m x 0.85 m, weight 45 kg.  
**No. 40495**

## Cast iron weights

Approx. 10 kg, plastic-coated.  
**No. 40498**

## Children's Net System

Sturdy aluminium system, 40 x 40 mm tubes. Easy to dismantle and to transport. Consists of 2 aluminium bases including posts, each 3.05 m long, 2 net holding rods and a nylon net. Dimensions 6.10 m x 0.85 m.  
**No. 40491**

## Children's Net System

Like article No. 40491 but with 6 rollers.  
**No. 40493**

## Children's Net Nylon

6.10 x 0.85 m  
**No. 40564**





# Kid's Tennis



## Youth Stage 2

Rubber lines for the original Stage 2 court. 2 side lines: 3 cm, 2 base lines 4 cm wide. Color white. Excellent UV resistance. Supplied with fixing nails and assembly instructions. Original length: 17.83 x 6.17 (single) or 8.23 m (double).  
**No. 45001**



## Youth Stage 3

Rubber lines for at least 2 original Stage 3 courts. 4 lines, 6.60 m each (can be extended to 11 m) color white. Excellent UV resistance. Supplied with fixing nails and assembly instructions. Includes tennis court lines.  
**No. 45002**



## Marking Lines for Kid's Tennis

Marking lines for small court tennis. Made of heavy-duty, non-slip and indestructible PVC. The weight of the line keeps it flat on the ground and it needs no additional fixation. Marking set of 2 rolls, 11 m long, 8 cm width.  
**No. 45000** white



## Street marking tapes

Made of high quality PVC, can be used on any surface. 4 corners and 12 lines.  
**No. 45006**



## Court marking tapes

Made of high quality PVC, can be used on any surface. 8 corners, 12 legs and 8 circles.  
**No. 45007**

## Circle marking tape

Made of high quality PVC, can be used on any surface. Set of 10, yellow.  
**No. 46044**

## Line marking tape

Made of high quality PVC, can be used on any surface. Set of 10, yellow.  
**No. 46040**

## Corner marking tape

Made of high quality PVC, can be used on any surface. Set of 10, yellow.  
**No. 46042**



Non-slip surface and needle valve.



# Training Devices



## Topcombat Set 1

Set contains: 3 x 6" hurdles • 3 x 9" hurdles • 2 coordination ladders • 1 large reaction ball • 1 small reaction ball • speed belt • pro leg toner • 2 kg medicine ball • 4 corner markers.

No. 43005



## Topcombat Set 2

Set contains: 2 x 4 m coordination ladders • 2 x 6" hurdles • 2 x 9" hurdles • 2 x 12" hurdles • parachute • 1 speed belt • 1 speed resistor • 1 reaction ball • 10 marker disks.

No. 43007



## Topcombat Set 3

Set contains: 1 x parachute • 1 x pro leg toner • 1 x speed belt • 1 x speed resistor 1 x, multi jumper • 1 x pro jumper • 1 x pro leg strength tube • 1 x pro power tube • 1 x reaction ball.

No. 43006



## Condition Training Package

This package contains practical aids for enhancing condition and reaction-training. Consists of: 1 coordination ladder, 8 m • 2 jump ropes, 3 m, orange • 2 jump ropes, 3m, yellow • 12 marking disks • 2 medicine balls - 2 kg • 2 fun ball, hard • 2 fun balls, soft.

No. 42050



## Hurdles Set

6 Hurdles, adjustable in height to 20 cm and 33 cm. Width 44 cm, complete with bag.

No 21560



## Jump Rope

Colored plastic rope with sturdy handle.

<b>No. 565</b>	red	230 cm
<b>No. 567</b>	yellow	240 cm
<b>No. 568</b>	green	250 cm
<b>No. 569</b>	blue	260 cm



# Training Devices



## Marking Plates

Made of soft PVC, diameter 19 cm, height, 50 plates in 5 different colors, per color 10 pieces  
**No. 20454** Packaging unit 50 plates



## Marking Markers

Ideal for marking in training. Soft hemisphere with 20 cm Ø in 4 different colors, height 9 cm, 40 pieces stacked on a carrier pole.  
**No. 20351**

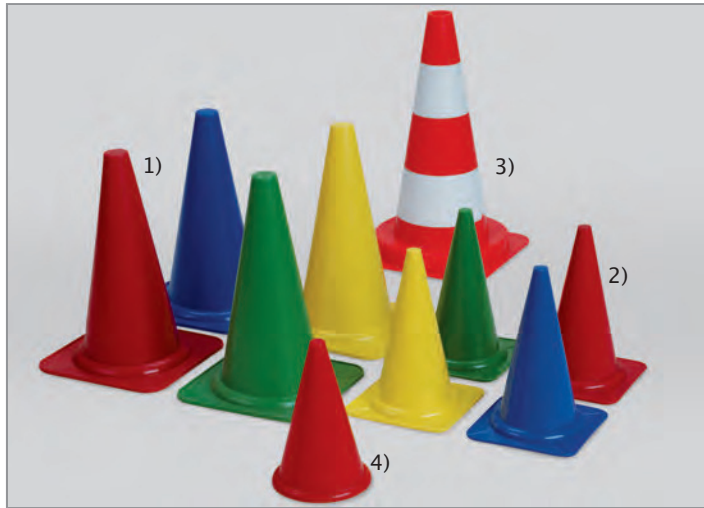

### 1) Marking Cone 40

Plastic, 40 cm high, for multiple use.  
**No. 20392** red, **No. 20393** yellow, **No. 20395** green, **No. 20396** blue

### 2) Marking Cone 28

Plastic, 28 cm high  
**No. 20373** red, **No. 20374** yellow, **No. 20375** green, **No. 20376** blue

### 3) Marking Cone 50

Heavy elastic plastic material, neon red with white stripes. 50 cm high.  
**No. 20390**

### 4) Marking Cone 23

Red plastic, 23 cm high.  
**No. 20377**

## Digit Sticker

Black one- or two-digit numbers on white background. 10 cm high.  
**No. 20388**



## Hockey Set

2 folding goals in a storage bag, along with 2 sets of 6 break-resistant sticks and 4 balls.  
**No. 34005**



## Coordination Ladder

Very good coordination and fitness training, due to flat strips fixed to a fabric band making injury almost impossible, suitable for many surfaces, robust quality.  
 Dimensions: 800 cm long, 50 cm wide, 45 cm distance between strips, complete with bag.  
**No. 42045**



# Training Devices



## Medicine Balls

Made of rubber with non-slip surface and needle valve.

<b>No. 22023</b>	1000 g
<b>No. 22025</b>	2000 g
<b>No. 22026</b>	3000 g
<b>No. 22027</b>	4000 g
<b>No. 22028</b>	5000 g



## Training Aid

The exercise/training aid for all types of sports is a complete training system with countless potential applications; from tennis, football, track and field, handball, basketball right through to motor sports. There are no limits to the imagination of trainers and athletes. The exercise aid can be used for school sports, basic training, right through to professional sports. Base can be filled with sand or other dry materials. Poles are made of high-grade elastic plastic. They can be inserted into the base or used as crossbars. The newly developed plastic clip can be set to any position. The poles can be positioned loosely or clipped onto other poles.

Complete set consists of:

2 bases, 3 poles 160 cm long, 2 solid plastic clips

**No. 20315** 1 set

**No. 20316** 5 sets

## Foot Plastic half bowls

**No. 20317**

**Plastic Pole** 160 cm long

**No. 20318**



## Slalom Poles

Poles are made of high-grade elastic plastic with a height of 160 cm. Available in the colors yellow and red, with a metal top of 10 cm. Ideal for careering and as marking.

**No. 20320** red

**No. 20321** yellow

## Slalom Pole Set

Consists of 5 red and 5 yellow poles including a practical bag.

**No. 20325**



# Information Boards



Showcase 41920



Showcase 41930



Showcase 41933



Showcase 41940



Showcase Type 41940 in Stand frame II



Details:

Keeping open system, safety lock, suspension system in stand frame, Stand Frame I

## Information Board TMD 95

Suitable for outside and inside use, absolutely weatherproof design. Made of top grade, torsion-free aluminium sections, depth 95 mm. The surface is anodized in matt silver (E6-EV1). State-of-the-art manufacturing processes and advanced processing machines have been combined with technical know-how to provide a solid basis for this quality product.

### Basic frame

Very robust aluminium base frame with inset steel back wall with corrosion-resistant coating.

### Front frame

Aluminium front frame made of torsion-free multi-chamber aluminium sections with integrated weatherproof rubber seal and shatter-proof acrylic glass pane.

### Front frame fitting

Special interlocking sections across the whole width so that no hinges are required; this provides greater stability.

### Front frame opening

The front frame opens upwards and is held open by rods which engage automatically. The catch is released by lifting the front frame up again.

### Safety lock

Safety lock located on the bottom edge with two keys. Simple and troublefree operation.

### Wall fastening

The information board is fastened to the wall by means of two aluminium section rails; the board is then inserted into the rails and fixed by two screws at the bottom. All fastening elements are accommodated in the frame sections. It is not possible to dismount the information board when it is closed. This protects it very effectively from theft.

### Showcase TMD 95

Measuring	mm	700 x 525	1000 x 850	850 x 1000	1350 x 1025
Width x height x depth 95 mm	mm	640 x 465	940 x 790	790 x 940	1290 x 960
Visible surface without lettering strip	mm	10	20	20	20
Incl. Magnets (Ø 30 mm)	piece	12	20	20	33
Weight	kg				
For outdoor and indoor use. Anodized (E 6 - EV 1) aluminium housing with black magnetic board, safety lock with two keys, wall fixing set.	Art.-No.	41920	41930	41933	41940
<b>Accessories</b>					
<b>Lettering strip, neutral</b> Acrylic glass 4 mm, translucent white, H 120 mm	Art.-No.	47100	47101	47102	47103
<b>Lettering strip, with lettering</b> Version as above, but with choice of text (print letters)	Art.-No.	47110	47111	47112	47113
<b>Pair of stands</b> To set in concrete. For free-standing installation, 2 aluminium square tubes 40 x 40 mm, height 2400 mm	Art.-No.	41947	41947	41947	41947
<b>Stand frame I</b> To set in concrete. Extremely stable frame made from square Alu tube for free-standing installation in front of a display case	Art.-No.	47160	47161	47162	47163
<b>Stand frame II</b> To set in concrete. Version as above, but for free-standing installation of 2 display cases side by side.	Art.-No.	47170	47171	47172	47143
<b>Magnets</b> Ø 30 mm, 10 per set	Art.-No.				41929

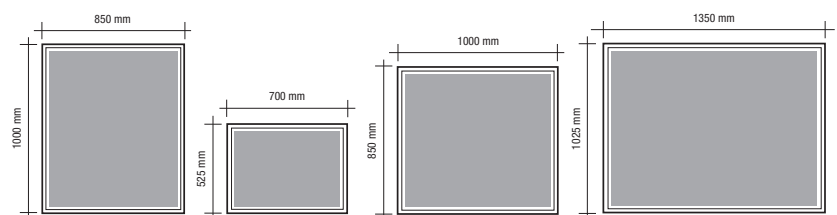



# Information Boards

**RANGLISTE**

R.	Herren	Damen	Senioren	Senioren	Junioren	Junioren
1						
2						
3						
4						
5						
6						
7						
8						
9						
10						
11						
12						
13						
14						
15						
16						
17						
18						
19						
20						
21						
22						
23						
24						
25						
26						
27						
28						
29						
30						
31						
32						
33						
34						
35						
36						

**RANGLISTE**

R.	Herren	Damen	Senioren	Senioren	Junioren	Junioren
1						
2						
3						
4						
5						
6						
7						
8						
9						
10						
11						
12						
13						
14						
15						
16						
17						
18						
19						
20						
21						
22						
23						
24						
25						
26						
27						
28						
29						
30						
31						
32						
33						
34						
35						
36						



## Tennis Court Reservation Clock

Each player can set the clock by hand for the period he wants to book the court.  
Size: 40 x 40 cm

**No. 41910**

## Ranking List I

Sturdy metal panel, galvanized and clamped in an aluminium frame, printed for women, men, senior men, senior women, junior boys and junior girls. For use with magnetic markers. Size: 50 x 68 x 2,5 cm. Please indicate required text with your order.

**No. 41950**

## Ranking List II

Like article No. 41950 but in an aluminium case with Plexiglass front pane, lockable. Size: 50 x 68 x 5 cm..

**No. 41960**

**RANGLISTE**

Gefordert werden darf:  
1. Die Spieler in der selben Reihe  
2. Die Spieler in der nächsthöheren Reihe rechts über dem Forderer

## Pyramid Ranking List I

Sturdy metal panel, galvanized and clamped in an aluminium frame, printed on weatherproof PVC film. Size: 68 x 50 x 2,5 cm.

**No. 41970**

**RANGLISTE**

Gefordert werden darf:  
1. Die Spieler in der selben Reihe  
2. Die Spieler in der nächsthöheren Reihe rechts über dem Forderer

## Pyramid Ranking List II

Like article No. 41970 but in an aluminium case with Plexiglass front pane, lockable. Size: 68 x 50 x 5 cm.

**No. 41980**

# Information Boards

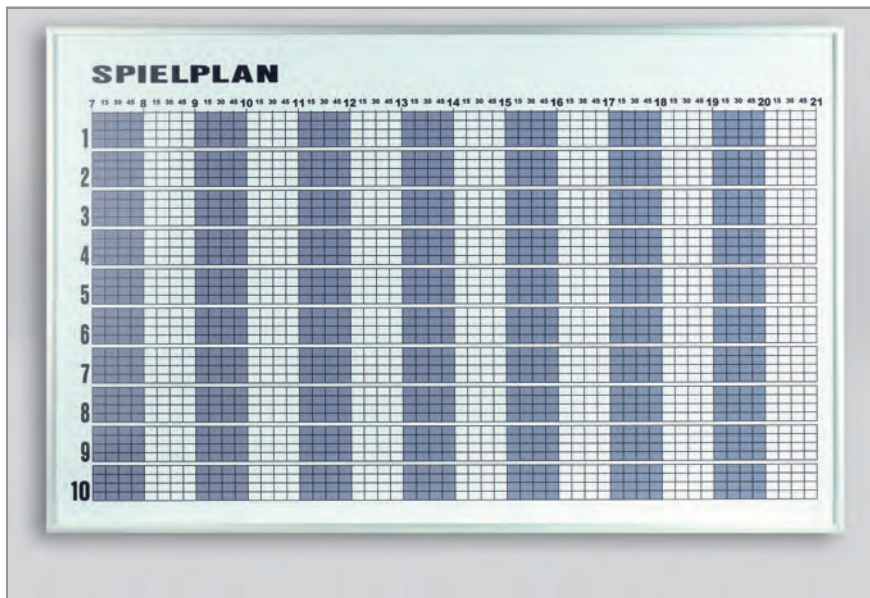

## Daily Information Plan

Bring order and clarity into the game by hanging magnetic nameplates in the corresponding sections. The chips can be marked in different colors for women, men, juniors, etc. The game times for team training, maintenance, trainer court, etc. can be clearly and easily reserved. The division into hours means that players can book between 45 and 115 minutes on court, more for doubles, by tagging the chips. The color-coded hourly division enables fast and easy time planning, especially for the lower courts. The sturdy metal panel is galvanized and clamped in an aluminium frame. The plan is printed brown on a white, photostable and weatherproof washable PVC film. Game times from 7 a.m. to 9:30 p.m.

- No. 41670** Plan for 4 courts, 120 x 38 cm
- No. 41680** Plan for 6 courts, 120 x 50 cm
- No. 41690** Plan for 8 courts, 120 x 68 cm
- No. 41700** Plan for 10 courts, 120 x 75 cm

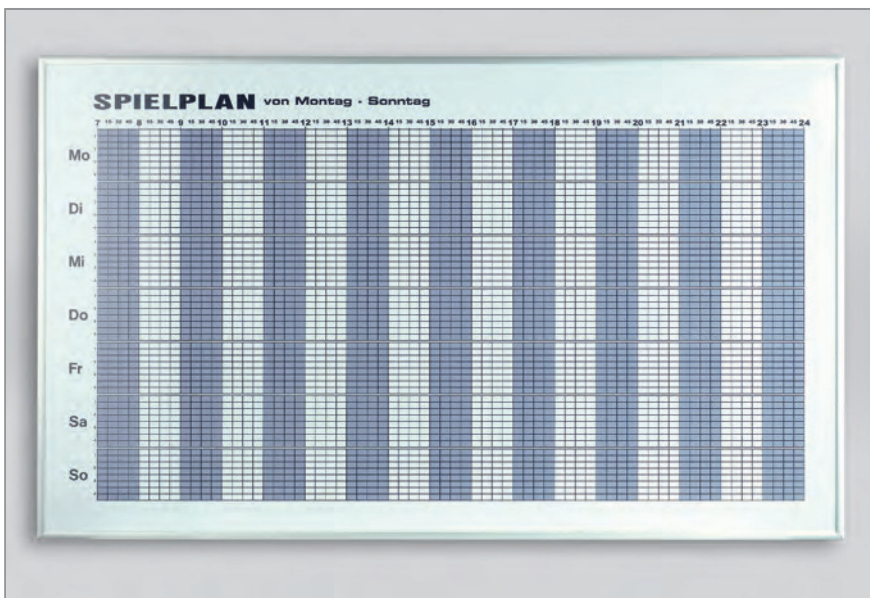

## Weekly Reservation Plan

As above, though for clear weekly reservations. Arranged from Monday to Sunday, game times from 7 a.m. to midnight.

- No. 41710** Plan for 2 courts 150 x 89 cm
- No. 41720** Plan for 4 courts 150 x 89 cm
- No. 41730** Plan for 8 courts 150 x 89 cm



## Storage Board

50 x 68 x 4 cm

**No. 41738**

## Magnetic Signs

60 x 10 mm

**No. 41740**

80 x 10 mm

**No. 41750**

## Embossing Tapes Dymo

9 mm wide, 3 m long, choice of color

**No. 41760**

## Embosser Dymo 1755

New, robust version

**No. 41770**





# Windscreens



## The high-quality screen, proven and tested thousands of times worldwide

Heavy-duty polyethylene fabric, UV-stabilized, lets wind through. Full border with plastic-lined brass eyes every 50 cm, thus very resistant to tearing.

**Wind Screen Super** The Quality Super weighs 160 g/qm is wind permeable and is available in the colours light- and dark green. It is the most sold wind screen. Only available in 12 x 2 m.

**Wind Screen Exclusive.** The quality of Wind Screen Exclusive weighs 140 g/qm and is extremely wind permeable and is excellently suited for printing, available in the colours light and dark green, yellow, white, blue, red and black. Standard size 12 x 2 m, but also available in length of 50 m and height of 4 m.

**Printing** The print is rolled on by hand twice with special UV-resistant ink. This ensures good adhesion and a long life. Print is normally done in black, however other colors can be printed on special request. Any company logo as well as standard lettering can be printed. Please contact our graphics department for special designs with your own lettering and logos. You will be sent draft forms free of charge which we will revise and present as final artwork ready for printing. Please contact us for further details.

## Spring Hooks

Galvanized, 60 hooks needed per 2 x 12 screen  
**No. 41530**

Technical changes reserved.  
Pictures are partially illustrations.



## Indoor Hall Covering

Top and sides with ring eyes, bottom weighted down with sewn-in lead tape.

## Perimeter Banners

Available in special sizes up to 4 meters in height and 50 meters in length in 10 different colors, with ring eyes or border stitching. Printed colors RAL-compliant.



# Windscreens



## Wind Screen Light Green

With metal eyelets every 50 cm. Dimensions: 12 m x 2 m.

- No. 415115** Super
- No. 41511** Exclusive



## Wind Screen Dark Green

With metal eyelets every 50 cm. Dimensions: 12 m x 2 m.

- No. 415105** Super
- No. 41510** Exclusive



## Windscreen Exclusive Color

With metal eyelets every 50 cm. Dimensions: 12 m x 2 m.

- No. 41512** blue
- No. 41513** white
- No. 41514** black
- No. 41515** yellow
- No. 41516** red



## Windscreen Exclusive with Advertising Printing

With metal eyelets every 50 cm. Dimensions: 12 m x 2 m.

- Color: light green or dark green
- No. 415171** printing up to 40%



## Windscreen Exclusive with Advertising Printing

With metal eyelets every 50 cm. Dimensions: 12 m x 2 m.

- Color: light green or dark green
- No. 415172** printing up to 60%



## Windscreen Exclusive with Advertising Printing

With metal eyelets every 50 cm. Dimensions: 12 m x 2 m.

- Color: light green or dark green
- No. 415173** printing up to 80%



## Windscreen Advertising Super printed with Universal Sport

With metal eyelets every 50 cm. Dimensions: 12 m x 2 m.

- No. 41500** dark green
- No. 41501** light green



## Windscreen Advertising Super printed with Court Royal

With metal eyelets every 50 cm. Dimensions: 12 m x 2 m.

- No. 41503** dark green
- No. 41504** light green



# Court Accessories



## Standard Dividing Net

Robust polyethylene net 2.4 mm thick, mesh width 4.5 mm. For tennis hall and outdoor use. Complete with steel wire, approx. 4 mm thick, 38 m long, 1 tension lock, lead cord weighs 200 g/m and nylon guide rings, 3 rings to be fitted to the net per meter.

### Size 40 x 2,5 m

No. 41570 white  
No. 41571 green  
No. 41572 black

### Size 40 x 3 m

No. 41580 white  
No. 41581 green  
No. 41582 black



## Standard Dividing Net Super black

The newly developed knotted dividing net is significantly more transparent due to its material thickness of only 1,6 mm. Mesh width 4,5 cm, complete with a 38 m long steel wire, 2 tension locks, lead cord weighs 200 g/m and 3 galvanized rings to be fitted to the net per meter.

No. 42500

## Support Rod

Made of aluminium, with large support base, free-standing. Freely adjustable by telescopic mechanism from 2 m to 3 m. 3 support rods are needed to support the standard dividing nets.

No. 41585



## Dividing and Stop Nets 2,3 mm

Made of high-strength polypropylene, mesh width 45 mm.

No. 41590 white

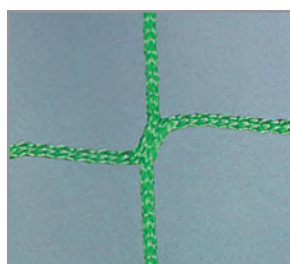

## Dividing and Stop Nets 2,3 mm

Made of high-strength polypropylene, mesh width 45 mm.

No. 41600 green

No. 41591 black

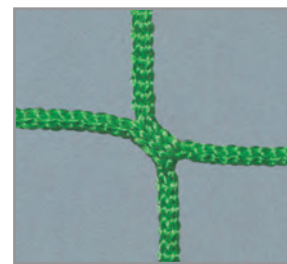

## Dividing and Stop Nets 3 mm

Made of high-strength polypropylene, mesh width 45 mm.

No. 41610 green



## Dividing and Stop Nets 4 mm

Made of high-strength polypropylene, mesh width 45 mm.

No. 41611 green



## Dividing and Stop Nets 4 mm

Made of high-strength polypropylene, mesh width 45 mm.

No. 41613 blue

## Lead Cord

Directly sewn to the net as weighting

No. 41620 200g

No. 41621 400g

## Plastic Guide Rings

Made of nylon, black, 3 integrated in the net for each meter

No. 41630

## Wire

Made of zinc-plated steel

No. 41640 4 mm

No. 41641 6 mm

## Tensioning Set

Eye rings and tension lock each end

No. 41650 for 4 mm

No. 41651 for 6 mm

## Additional charge for small orders per single net:

nets of less than 5 sqm + 100%    nets of less than 20 sqm + 20%

nets of less than 10 sqm + 35%



# Court Accessories



## Uniflex 2006

The verified multi-functional and movable covering. The hard-wearing multi-purpose covering for indoor and outdoor use. The material is weather persistent, non-fading, ageing persistent, hygienic (athlete's foot resistant), oil- and chemical resistant, acid-resistant, water-permeable and quickly dry. The special surface is extremely non-slip, especially when wet. The ideal covering for any kind of wet zones like changing rooms, showers, sauna, swimming pools, wash houses, garages and workrooms etc. Uniflex 2006 is made from recyclable UV-resistant polypropylene and is available in size 300 x 300 x 14 mm in the standard colors of blue, green, grey and red, and on request in special colors white and grey/black.

- No. 42162 blue
- No. 42161 green
- No. 42160 red
- No. 42163 grey
- No. 42166 white

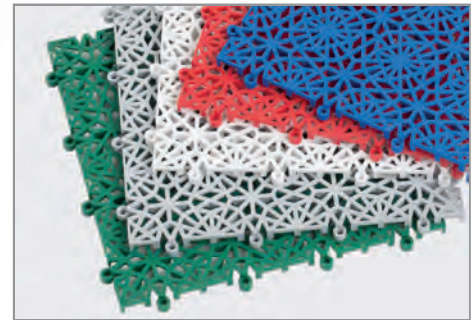

## Megaphone TM-10

Built-in microphone, siren switchable, volume control, output power: 10 W max., average sound pressure (1 W/m): 90dB, size: Ø 158 mm, length 244 mm, weight 595 g, power pack: 8 x 1,5 V-(AA)-Mignon-cells (not contained in consignment).

No. 10500



## Megaphone TM 22

Low weight and low power consumption through Piezo-Technology. Built-in microphone, siren and controllable signal sound, volume control, battery-status indication, output power: 20 W max., average sound pressure (1 W/m): 115 dB. Size: Ø 195 mm, length 315 mm, weight 850 g, power pack: 8 x 1,5 V-(AA)-Mignon-cells (not contained in consignment).

No. 10501



## Megaphone TM-17

Hand-microphone with spiral cable, speaking locking button and volume control at the microphone, operating breaker for siren, language and whistle, socket for external 12-V-battery-operation, automobile-connection cable, output power: 25 W max., average sound pressure (1 W/m): 110 dB, size: Ø 230 mm, length 340 mm, weight 1,7 kg, power pack: 8 x 1,5 V (C) Baby-battery (not contained in consignment), ext. 12 V=2A,12-V-connection.

No. 10502



## Megaphone TM-27

Built-in microphone, siren switchable, volume control, socket for external 12-V-battery operation, automobile-connection, output power: 25 W max., average sound pressure (1 W/m): 115 dB, size: Ø 230 mm, length 370 mm, weight 1,7 kg, power pack: 8 x 1,5 V (C) Baby-battery (not contained in consignment), ext. 12 V=2A,12-V-connection.

No. 10503



# Court Accessories



## Mobilissima Tribune Seating Indoor

Mobilissima tribune seating can be used anywhere, indoors or out. Quickly assembled, each unit offers seating for up to 50 spectators. Any number of sets can be linked together to provide the required number of places. The seating occupies just 3.8m<sup>2</sup> in storage as the elements are designed to fit one within the other. They are supplied preassembled. Only the wheels need to be screwed on. The tribune can easily be moved and erected by a person working alone. Steel framework, RAL 7016 (plastic-coated); seats made of glued plywood sheets, natura beech, treated twice with DD lacquer, edges smoothed and sealed with a colorless coating. The walkways and steps are made of glued plywood, natural beech, treated twice with DD lacquer, step edges smoothed and sealed with a colorless coating, wheels are polyamide, Ø 100mm, runners have a robust felted covering.

### Technical data

Length: 875 cm  
 Height: 185 cm  
 Width: 180 cm  
 Weight of each set: approx. 500 kg  
**No. 40965** indoor, incl. preassembly

### Supplied

- 5 rows of tribune seating - length varies
- 5 back rails
- 2 side rails
- Instructions

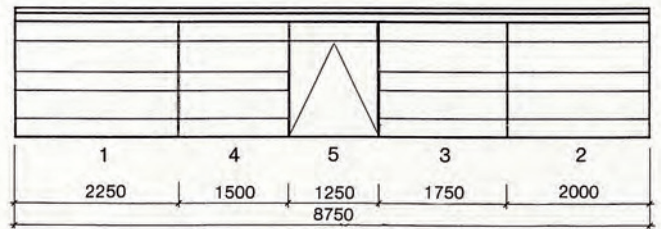

## Mobilissima Tribune Seating Outdoor

Details and dimensions like article No. 40965, except that the steel framework is galvanized, seats are made of plastic, wheels Ø 100 mm, walkways and steps made of aluminium anti-slip plate.

**No. 40966** outdoor, incl. preassembly

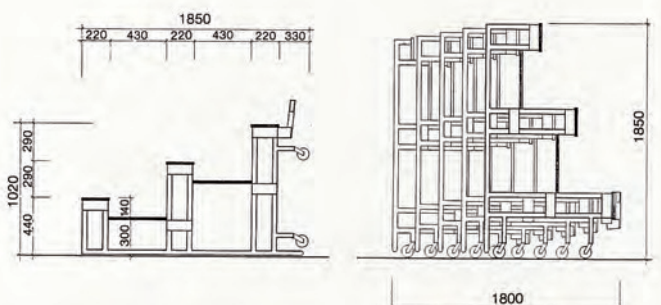



# Court Accessories

## Compact

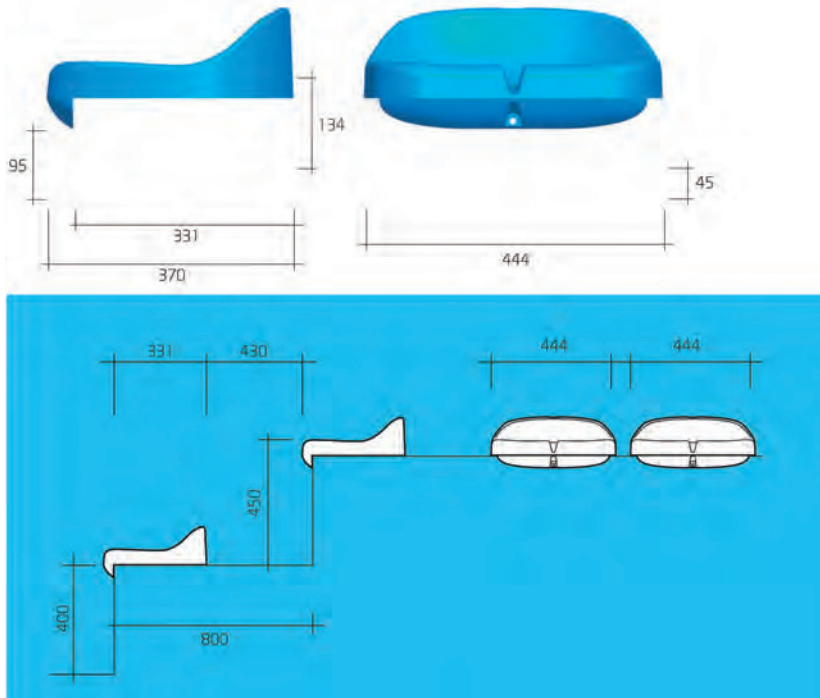

RAL 9017

RAL 9016

RAL 2008

RAL 6001

RAL 5015

RAL 1018

RAL 3002

RAL 7001

## Elegance

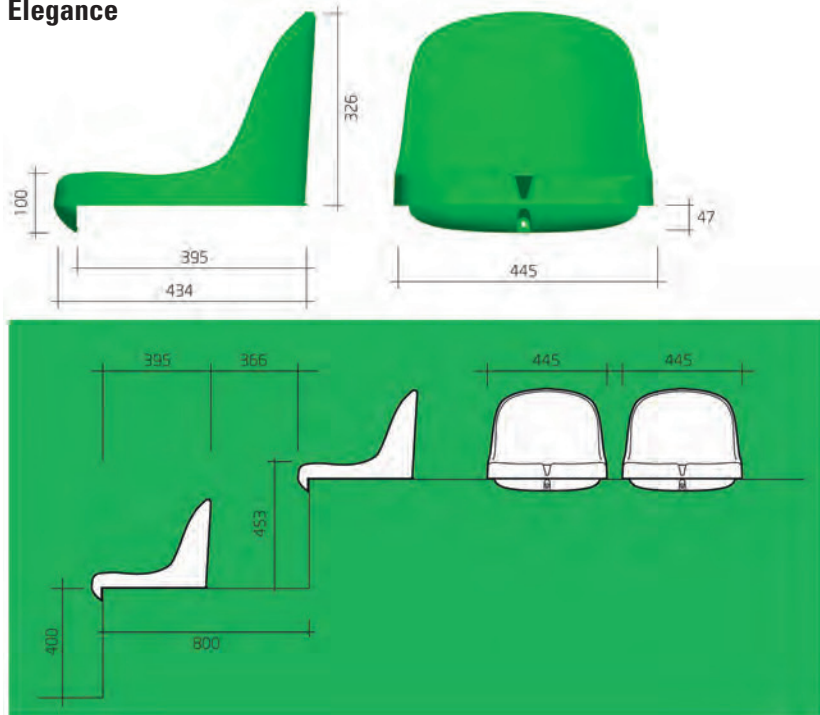

### Tribune Seats for Self-Installation

Made of squirted polypropylene, flame-retardant, impact-proof, UV-resistant, according to DIN 4102B1. Fast and easy installation on almost any ground due to threefold screw connection. The fastening points are protected against vandalism. All seats are equipped with a water outlet. Available in the colors black, white, orange, green, blue, yellow, red and grey. Suitable for indoor and outdoor tribunals. Upon request the seats can be numbered.

### Tribune Seats Compact

No. 40962 0.810 kg

### Tribune Seats Elegance

No. 40963 1.930 kg







### Youth Soccer Goal Court Royal 3 x 2 m, completely welded, in 4 parts

The newly developed Youth Soccer Goals Court Royal are delivered in four parts. Their stability comply with the fully welded aluminium-goals. The fully welded side frames are joined by 102 mm long round profile bars which are fitted with very sturdy interior profiles to join the parts together. Goalposts and bars are white-powder-coated. The warp-resistant profile is fitted with a particularly deep groove, in which the plastic net-holders are inserted. According to regulations a tilt-resistant ground anchoring for grassy fields is included. Alternatively anti-tilt weights for synthetic fields are available. The goal meets the FIFA and DFB standards and is produced according to DIN EN 748.

Dimensions: 3 x 2 m, Depth at base: 1,25 m

No. 202022

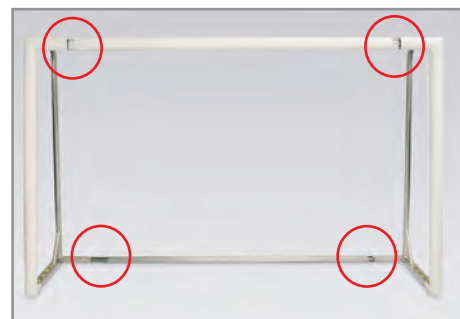

### Youth Soccer Goal Court Royal 5 x 2 m, completely welded, in 4 parts

The newly developed Youth Soccer Goals Court Royal are delivered in four parts. Their stability comply with the fully welded aluminium-goals. The fully welded side frames are joined by 102 mm long round profile bars which are fitted with very sturdy interior profiles to join the parts together. The warp-resistant profile is fitted with a particularly deep groove, in which the plastic net-holders are inserted. According to regulations a tilt-resistant ground anchoring for grassy fields is included. Alternatively anti-tilt weights for synthetic fields are available. The goal meets the FIFA and DFB standards and is produced according to DIN EN 748.

Dimensions: 5 x 2 m, Depth at base: 1,5 m

No. 202021

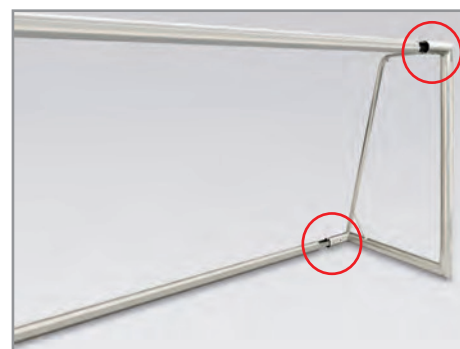

### Youth Soccer Goal Net Borussia

Very sturdy net made of high-strength 4 mm polypropylene.

No. 20240 green

No. 20241 white



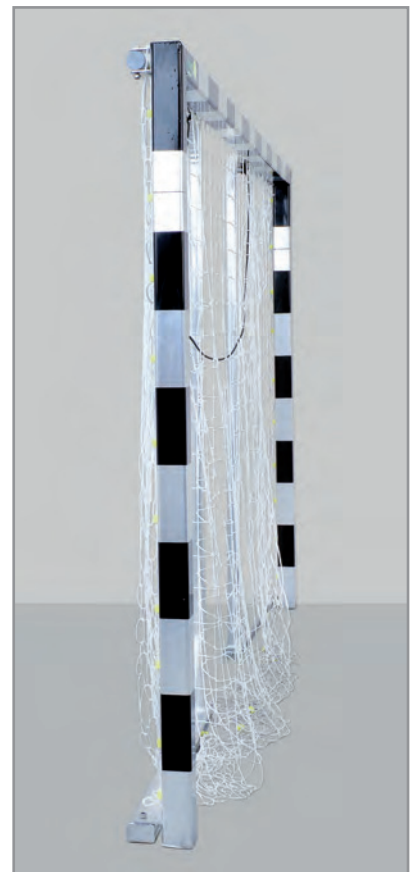

## Handball Goal Court Royal

According to safety standard DIN-EN 749, goal frame 3 x 2 m welded, standard goal depth 1.25 m (optional 1.45 m). Made of especially thick-walled 80 x 80 mm aluminium profile with rounded edges, base pipe for screwing in, very sturdy rear construction base frame made of 75 x 50 mm square aluminium profile with guide groove, net hoop made of 50 x 3 mm round pipe for free net suspension (the net is not pulled over the hoops).  
**No. 20520**



## Small Field and Handball Goal Net

High-Strength 4 mm polypropylene

**No. 20610** white

**No. 20611** green



## MINI Aluminium Exercise Goal

120 x 80 cm, 80 cm deep. Hinged net brackets, with floor tube. Complete with net made from high-strength 3 mm polypropylene. 10 cm mesh width.

**No. 202081** adjustable

**No. 2020811** fully-welded

**No. 202082** mesh width 10 cm

**No. 202083** mesh width 4.5 cm

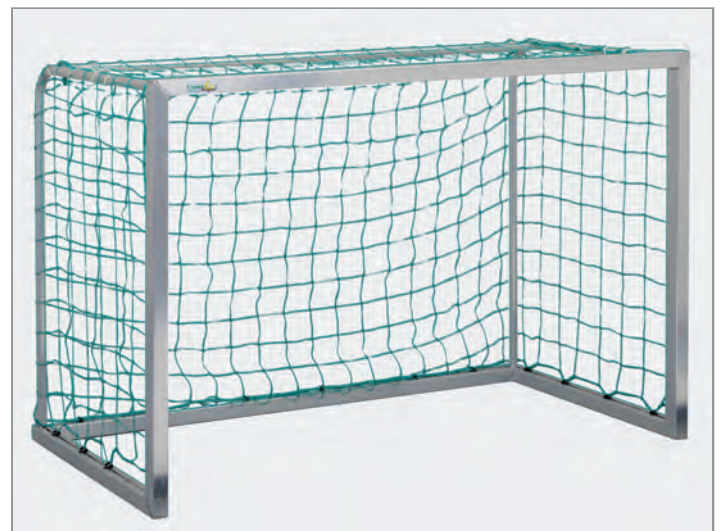

## MAXI Aluminium Exercise Goal

180 x 120 cm, 80 cm deep. Hinged net brackets, with floor tube. Complete with net made from high-strength 3 mm polypropylene. 10 cm mesh width.

**No. 202091** adjustable

**No. 2020911** fully-welded

**No. 202092** mesh width 10 cm



# Sport and Games



**Volleyball Posts Court Royal 80 Steel**  
Very sturdy volleyball posts 80 x 80 mm, made of steel, coated in white. Net attachment and tensioning device galvanized, smooth-running and continuously adjustable. Height of post from the ground 300 cm. Complete with ground sleeves  
**No. 30505**



**Volleyball Post Universal 80 Aluminium**  
Reliable, solid volleyball post 80 x 80 mm aluminium, compliant with DIN 7896. Easy-running net attachment and tensioning devices (galvanized, trapezoid thread mechanism) continuously adjustable. Surface of the posts and impulse profiles are matt-silver anodized. Complete with ground sleeves and covers.  
**No. 30500**



**Volleyball Post Universal 83 Aluminium**  
Reliable, solid volleyball post 83 mm made of aluminium special profile, compliant with DIN 78966. Easy-running net attachment and tensioning devices continuously adjustable. All steel parts are galvanized. Post surface is matt-silver anodized. Complete with ground sleeves and covers.  
**No. 30501**



**Volleyball post Special 80**  
Top volleyball post 80 x 80 mm made of aluminium profile compliant with EN 1271. Extra sturdy construction including slider with roller and tensioning device, crank as well as net hooks. Surface matt-silver anodized. Complete with ground sleeves and covers.  
**No. 30520**



**Volleyball post Special 83**  
Top volleyball post 83 mm made of aluminium profile compliant with EN 1271. Extra sturdy construction including slider with roller and tensioning device, crank as well as net hooks. Surface matt-silver anodized. Complete with ground sleeves and covers.  
**No. 30502**



### Aluminium Umpire's Chair

Aluminium volleyball umpire's chair made of round profile Ø 35 mm. Simple height adjustment, 3 possible settings, complete with 4 rubber feet, 2 straps for fastening to volleyball post, plastic table.  
**No. 30600**



### Aluminium Umpire's Chair Royal

Aluminium construction, height continuously adjustable with crank. Entrance via ladder at rear. Four adjustable rubber feet, webbing for fastening to volleyball post, table and back made of PE500.  
**No. 30610**



### Volleyball Antenna one piece

With GVF certification mark, length 180 cm, complete with bag and marking tape.  
**No. 30675**



### Volleyball Net Training

Robust design made of 2 mm polyethylene cord with 11.70 m long steel rope. Dimensions according to regulations 9.50 m long, 1 m high, mesh size 10 cm.  
**No. 30620**



### Volleyball Net Tournament

Especially used for outdoor use, very sturdy design made of 3 mm polyethylene cord with 11.7 meter long steel wire. Size compliant with regulations: 9.5 meter long, 1 meter high, mesh size 10 cm.  
**No. 30660**

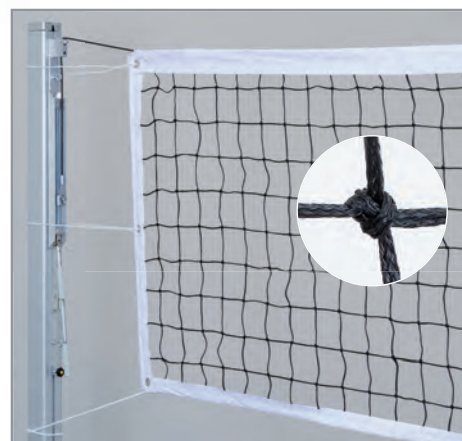

### Beach Volleyball Net UNIVERSAL

Black polyethylene net 2 mm, 9.5 m long, 1 m high, top with 50 mm wide edging in neon-yellow Universal Sport logo.  
**No. 30684**





## Volleyball Post Heavy Duty

Absolutely weatherproof, very sturdy, vandalism-proof, competition-approved volleyball post made of 90 x 90 x 4 mm hot-dip galvanized steel profile. Height adjusted with a very easy-to-handle mechanism. Net tensioned with a turnbuckle. Complete with ground sleeves 35 cm. Post length 300 cm.

**No. 30510**



## Beach Volleyball Post Court Royal 83

83 mm Ø aluminium (DIN 7896). Easy running net attachment and tensioning devices (galvanized, trapezoid thread mechanism) steplessly adjustable. Surface is yellow powder-coated. Including ground sleeves made of aluminium, 35cm long.

**No. 30693**



## Beach Volleyball Marking Lines

9 x 18 m, made of polyester tape 50 mm, with loops at each corner and middle marking. Complies with the GVF (German Volleyball Federation) requirements. Wounded onto a plastic reel. Complete with 4 ground anchors,

**No. 30688** color: dark blue

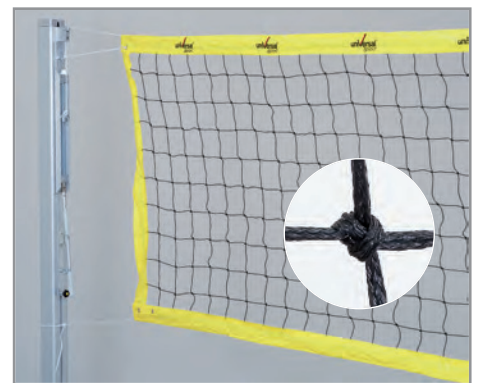

## Beach Volleyball Net UNIVERSAL

Black polyethylene net 2 mm, 9.5 m long, 1 m high, with 50 mm wide edging in neon-yellow Universal Sport logo.

**No. 30684**



## Beach Volleyball Net

Black polyethylene 2 mm, 9.50 m long, 1 m high, with pink edging 50 mm wide.

**No. 30680**

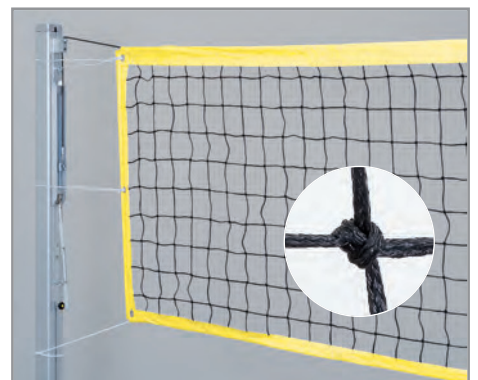

## Beach Volleyball Competition Net

Top 3 mm, low-stretch polyester tensioning rope, bottom 4 mm tensioning rope. With 4 tensioning cords as well as 75 mm wide coated edging in neon yellow.

**No. 30681**



## Beach Volleyball Marking Lines Turnier

9 x 18 m (or 8 x 16 m) with adjustable plastic corner elements, 50 mm wide PES-webbing and middle marking. Complete with 4 plastic ground anchors, 23 cm long and bungee tensioning ropes. color: dark blue.

**No. 30686**

# Sport and Games



## Universal Sport Posts Free-Standing

Can be used both outdoors and indoors. The multigame system that has been developed by Universal Sport is suitable for games involving nets and lines. The easily legible scale with game markings enables easy height adjustments, even if the net has already been erected. The system consists of two base frames, each weighing 60 kg, and 12 plastic-coated cast iron weights, each weighing 10 kg. The total weight per stand is therefore 120 kg. The rubber wheels with mounted ball-bearings make it easy to transport the system and the weights. In order to make the system easier to transport on uneven surfaces the cast iron weights can be removed, which reduces the weight by 60 kg and allows you to access any playing field. This makes any additional transport equipment unnecessary.

The rear side of the system is equipped with protective rubber pads. The plastic-coated 50 x 50 steel columns can be adjusted from 1.55 m to 2.45 m and are equipped with a safety lock. The scope of delivery includes an all-purpose net (length 6.10 m). The following games can be played: Tennis - Mini tennis - Fistball - Volleyball - Beach volleyball - Foot tennis - Indica - High jump with Zacharias bar.

The system has been designed in compliance with the GBF guidelines and is therefore suitable for badminton tournaments.

**No. 32001**

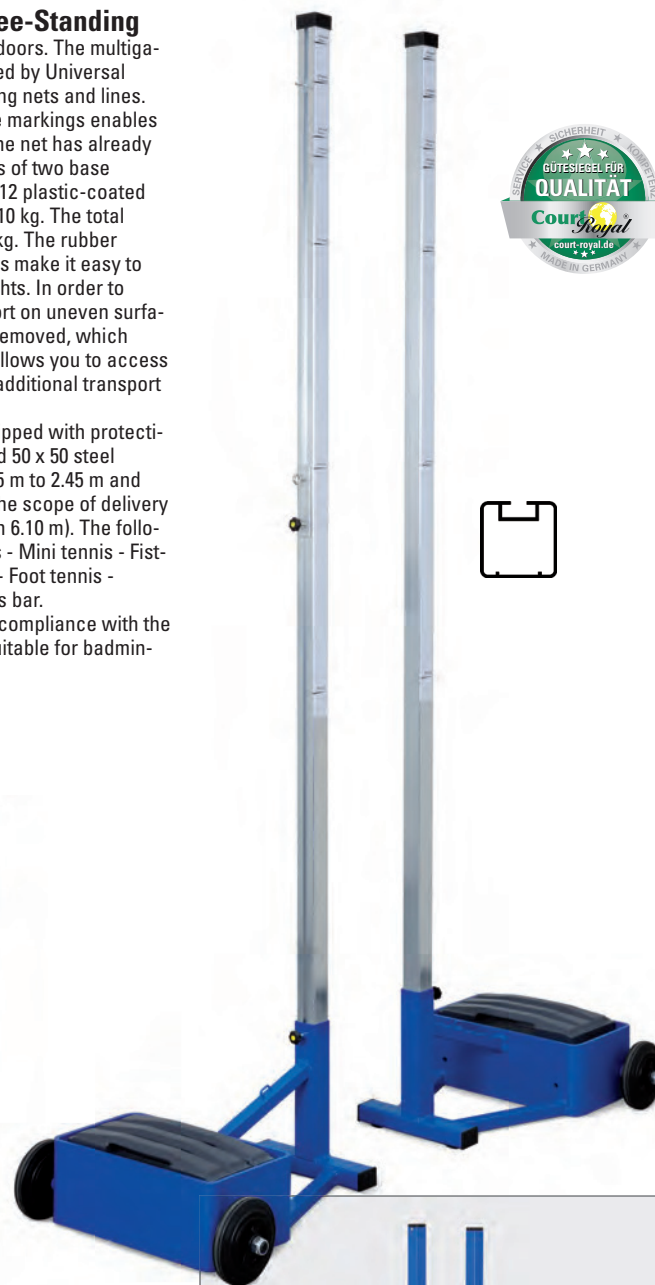

## Badminton Post Hobby

Movable free-standing system with rubber wheels on the weighted base. Posts made of 40 x 40 mm steel pipe. Complete with hooks and tensioning belt, painted blue. Weight per post approx. 25 kg, radius 60 cm

**No. 30803**

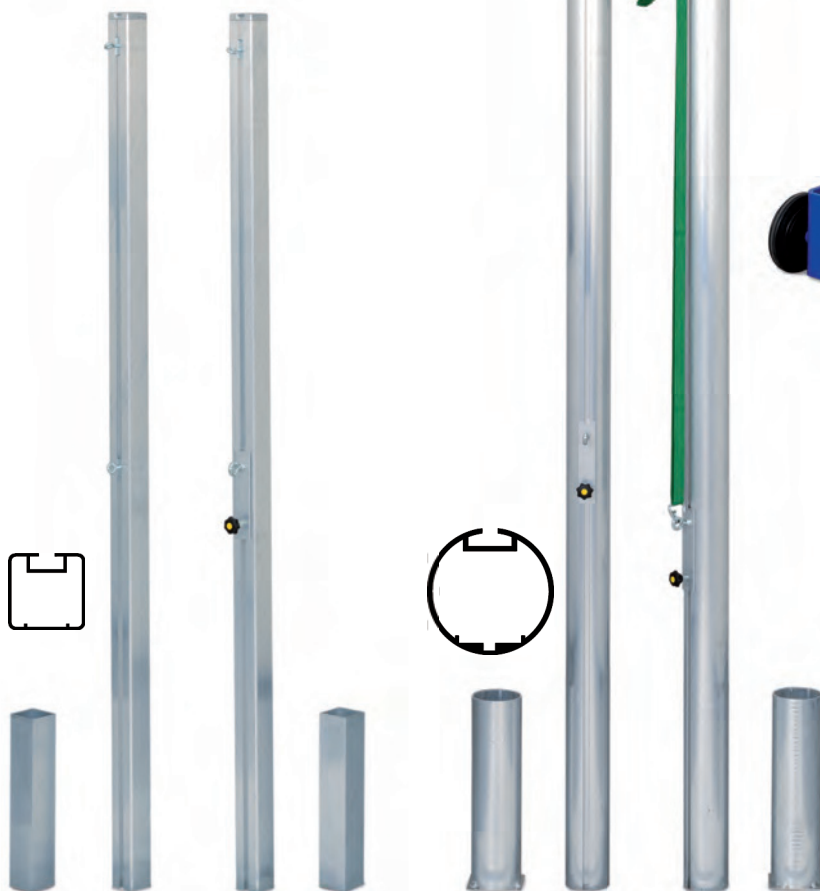

## Badminton Post I

For competitions and school sports. Post made of 50 x 50 mm aluminium profiles. Complete with hooks, tensioning belt and ground sleeves.

**No. 30802**

## Badminton Post II

For competitions and school sports. Posts made of 83 mm aluminium special profile. Complete with hooks, tensioning belt and ground sleeves.

**No. 30802**



# Sport and Games



## Badminton Umpire Chair

Elegant aluminium badminton umpire chair with European Seal of Approval DIN EN 131. Very robust because of the stable ladder and the projecting supports with four base plates. The seat mount has an extra crossbar behind the UV-resistant body-contoured seat. Including writing-board.

**No. 30888**



## Badminton Post Competition

Movable, free-standing system with rubber wheels and protective rubber pads. Posts made of 50 x 50 cm aluminium pipe complete with hooks and tensioning belt. Blue, hammertone-enameled. Other colors on request. Weight of each post approx. 70 kg. Rear extension 60 cm

**No. 30820**



## Additional Weight Badminton Post Court Royal

Approx. 35 kg each for competition

**No. 30825**

## Badminton Post Court Royal Tournament

According to DBV (German Badminton Federation) regulations. This system consists of two base frames, 60 kg each, as well as 12 plastic-coated cast iron weights, 10 kg each. This means a total weight of 120 kg for each post. The system has protective rubber pads. The 50 x 50 mm posts come complete with a tensioning belt. Solid rubber wheels mounted on ball-bearings enable easy transport with the weights. By taking off the weights and the posts the system can be easily stored and transported.

**No. 30831**



## Cast Iron Weights

Approx. 10 kg, plastic-coated

**No. 40498**



## Badminton Net Training

Made of 1 mm nylon cord, with tensioning cord. Size 6.10 m wide, 76 cm high. Mesh size 20 mm, edged all round.

**No. 30840**

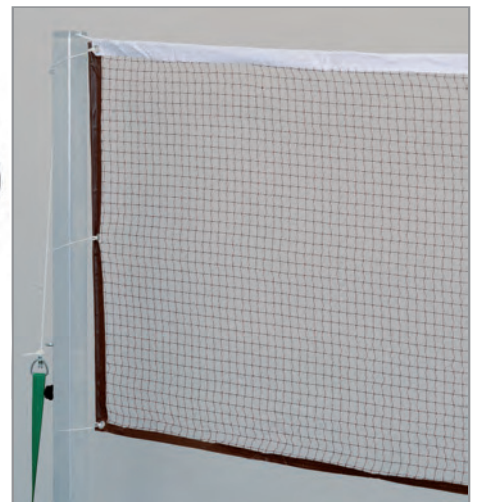

## Badminton Net Olympia

Made of 1.2 mm nylon line with tensioning steel wire, 6.60 m long. Size 6.02 m wide, 76 cm high, mesh size 18 mm, edged all round.

**No. 30860**



## Badminton Net Super Cup DIN

Competition net, compliant with DIN EN 1509 made of 1.4 mm nylon cord with 8 m long tensioning Kevlar cord and lateral polyester rods. Size 6.02 m wide, 76 cm high, mesh size 18 mm, edged all round.

**No. 30850**



# Sport and Games



## Royal Streetball System with GFK Backboard, round

Stable single-post structure made from 90 x 90 mm steel tube, hot-dip galvanized with screw-on plate for basket. FRP backboard 120 x 90 cm with DIN basket and net, including ground sleeve.

**No. 30026** Projection 120 cm  
**No. 300220** Projection 165 cm



## Royal Streetball System with Grid Backboard

Stable single-post structure made from 90 x 90 mm steel tube, hot-dip galvanized with screw-on plate for basket. Grid backboard 120 x 90 cm with DIN basket and net, including ground sleeve.

**No. 300262** Projection 120 cm  
**No. 300222** Projection 165 cm



## Streetball Unit Heavy Silent

All-metal competition streetball system made of galvanized steel pipe 114 x 4.5 mm. Steel grid board, extra low-noise, hot-dip galvanized, 120 x 90 cm. Powder-coated with flat iron enhancement for fixing. DIN drill-holes, with chain net.

**No. 300230**



All facilities complete with basket, board and ground sleeve.



## Big Duty Basketball System

Steel tube single-pole frame made from square profile 15 x 15 cm, hot-dip galvanized, projection 165 cm, fully welded. Including target backboard made from 8 mm solid aluminium 120 x 90 cm, painted white. Including super-stable basket ring with chain net, galvanized. Basket is screwed directly to frame and therefore prevents target backboard from being damaged if subjected to extreme stress. The system is extremely stable, weather-resistant, maintenance-free and vandalism-proof, therefore ideal for use on public playgrounds and sports facilities.

**No. 30027** backboard square  
**No. 30038** backboard round





### Basketball Goal DIN red

According to international standard. Red powder-coated, complete with back plate with DIN drill holes 11 x 9 cm. EN 1270. Without net.  
**No. 300229**

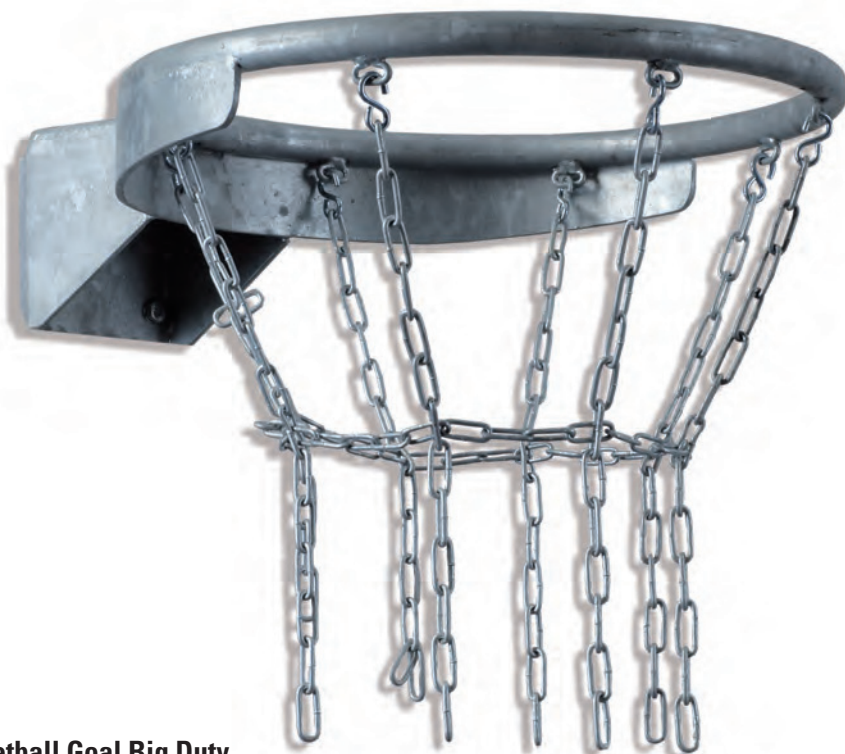

### Basketball Goal Big Duty

Indestructible basketball basket made of hot-dip galvanized steel pipe 27 mm diameter with flat iron enhancement. With DIN drill holes 11 x 9 cm. EN 1270. Without net.  
**No. 30228**



### Basketball Goal Hobby red

Solid design, red powder-coated. 45 cm ring. Complete with net. Drill holes 7.5 x 6.5 cm.  
**No. 300203**

### Basketball Goal Junior

Solid design, red powder-coated. 35 cm ring. Complete with 8 loop net. 2 hole pattern.  
**No. 300213**



### Basketball goal DIN – reinforced

Same as 30220, but with reinforced ring and bar, red powder-coated, complete with back plate. According to international standard with DIN drill holes 11 x 9 cm. EN 1270. Without net.  
**No. 30224**



### Streetball Goal Flex 30

Simple retractable goal with self-contained cage. Red powder-coated with DIN drill holes 11 x 9 cm. EN 1270. Without net.  
**No. 31040**



### Basketball Goal Flex 70

Competition goal according to international standard. Double-spring retracting mechanism in self-contained safety cage. Resists loads of up to 70 kg on the ring. Red powder-coated with DIN drill holes 11 x 9 cm. EN 1270. Without net.  
**No. 30227**

# Sport and Games



## Streetball Set Street

Weather-resistant plastic backboard 112 x 73 cm. Complete with basket and net.  
**No. 310208**



## Bronx Streetball Set

Weather-resistant, recyclable plastic backboard 112 x 73 cm, basket and net and wall mounting facility on back with projection of 22 cm. Extension 30 cm.  
**No. 31010**



## Wall Mount

Wall fastening with approx. 30 cm or 60 cm extension.

### No. 300682

DIN drill holes 7.5 x 6.5 mm, 30 cm extension

### No. 300683

DIN drill holes 11 x 9 mm, 60 cm extension

## Harlem Streetball Set

Weather-resistant plastic backboard 120 x 90 cm, goal with DIN drill holes and net. Wall attachment with 30 cm extension.  
**No. 310103**



## Streetball Unit New York

Powder-coated steel post  $\varnothing$  approx. 95 mm to be set into concrete. Board 112 x 73 cm, basket  $\varnothing$  45 cm and net height adjustable from 2.00 to 3.05 m. Extension 60 cm

**No. 31020**



## Streetball Unit Atlanta

Free-standing, robust mobile system made from powder-coated steel tubing approx. 95 mm  $\varnothing$ . The base can be filled with sand (approx. 190 kg). Weather-resistant, recyclable plastic backboard 112 x 73 cm complete with solid steel basket 45 cm  $\varnothing$  and nylon net. Basket height 3.05 m.

**No. 310201**



## Streetball Unit Los Angeles

Free-standing, robust mobile system made from powder-coated steel tubing. The base can be filled with sand (approx. 190 kg). The height of the basket can be automatically adjusted using a lever from 3.05 m (competition) to 2.10 m (kids). Weather-resistant, recyclable plastic backboard 112 x 73 cm, complete with solid steel basket 45 cm  $\varnothing$ , nylon net and arm.

**No. 310203**



# Sport Field Dimensions

## Dimensions of large sports fields in accordance with DIN 18035, Part 1

Type of sport	Field size				safety zone		usable sports area	
	in acc. with competition rules		standard size		sides	ends	total size	
	width m	length m	width m	length m	each m	each m	width m	length m
Field handball	55 bis 65	99 bis 110	60	90	1	2	62	94
Field hockey	55	91,40	55	91,40	2	4	59	99,40
Soccer	45 bis 90	90 bis 120	68	105	1	2	70	109
Basketball	30 bis 40	75 bis 90	35	80	1	2	37	84
Rugby	68,40	100	68,40	100	2	12 to 23	72,40	124 to 146

## Dimensions of small sports fields in accordance with DIN 18035, Part 1

Type of sport	Field size				safety zone		usable sports area	
	in acc. with competition rules		standard size		sides	ends	total size	
	width m	length m	width m	length m	each m	each m	width m	length m
Badminton	6,10	13,40	6,10	13,40	1,25	1,25	8,60	15,90
Basketball	13 to 15	24 to 28	14 <sup>1)</sup>	26 <sup>1)</sup>	1	1	16	28
Fistball	20	50	20	50	6	8	32	66
Small pitch handball	18 to 22	38 to 44	20	40	1	2	22	44
Small pitch hockey	18 to 22	38 to 44	20	40	1	2	22	44
Small pitch soccer	15 to 25	30 to 50	20	40	1	2	22	44
Basketball	25	60	25	60	1	2	27	64
Bounce ball	8	16	8	16	2	4	12	24
Quoits	5,50	12,20	5,50	12,20	3	3	11,50	18,20
Roller-skate hockey	15 to 20	30 to 40	20	40	–	–	20	40
Roller skating	20	40	20	40	–	–	20	40
Tennis	10,97	23,77	10,97	23,77	3,65	6,40	18,27	36,57
Volleyball	9	18	9	18	2	3	13	24

<sup>1)</sup> Measured from the inner edge of the line, further admissible measurements are 15 x 28 m and 13 x 24 m

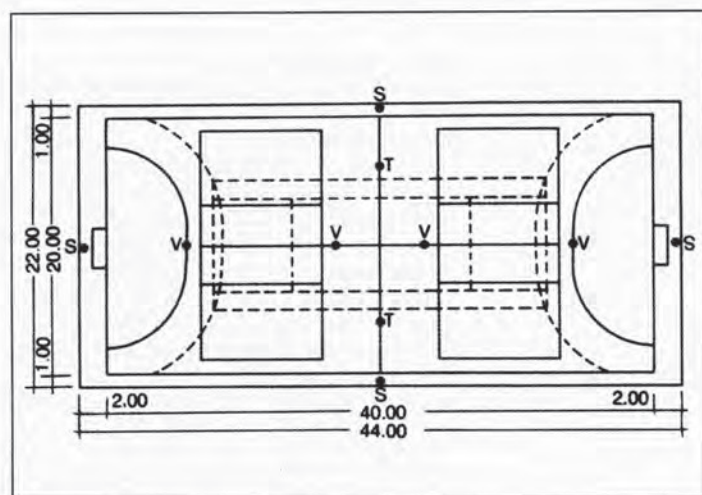

### Small sports field, 22 x 44 m

divided up for various sports as follows:  
lengthways: handball, tennis  
widthways: volleyball (2 x)

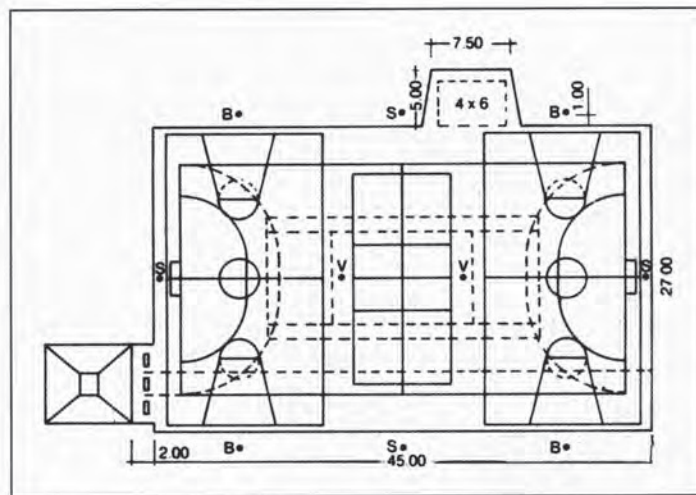

### Small sports field, 27 x 45 m

divided up for various sports as follows:  
lengthways: handball, tennis, long jump  
widthways: basketball (2 x), volleyball, high jump